

RECEIVED
MMS COM OCS REGION
NOV 25 1996

REGISTRATION
SECTION

In Reply Refer To: MS 5231

November 15, 1996

PUBLIC INFORMATION UNIT

OEDC Exploration & Production, L.P.
Attention: Mr. Joseph L. Savoy
Post Office Box 9738
The Woodlands, Texas 77387-9738

BEST AVAILABLE COPY

Gentlemen:

Reference is made to the following plan received September 26, 1996:

Type Plan - Initial Development Operations Coordination Document
Leases - OCS-G 6397 and 6398
Blocks - 1 and 2
Area - Destin Dome
Activities Proposed - Two wells and two caissons

In accordance with 30 CFR 250.34, this plan is hereby deemed submitted and is now being considered for approval.

Your control number is N-5543 and should be referenced in your communication and correspondence concerning this plan.

Sincerely,

(Orig. Sgd.) Kent E. Stauffer

Donald C. Howard
Regional Supervisor
Field Operations

bcc: Lease OCS-G 6397 POD File (MS 5032)
Lease OCS-G 6398 POD File (MS 5032)
MS 5034 w/public info. copy of the plan
and accomp. info.

SCANNED

MTolbert:cic:11/15/96:DOCDCOM

NOTED - SCHEXNAILDRE

OEDC EXPLORATION & PRODUCTION, L.P.

November 6, 1996

Mr. Donald C. Howard
Regional Supervisor
Office of Field Operations
U.S. Department of the Interior
Minerals Management Service
1201 Elmwood Park Boulevard
New Orleans, LA 70123-2394



BEST AVAILABLE COPY

RE: Initial Joint Development Operations Coordination Document, Control No. N-5543, Leases OCS-G 6397/6398, Destin Dome Blocks 1 and 2, OCS Federal Waters, Gulf of Mexico, Offshore, Alabama

Gentlemen:

By letter dated October 29, 1996, Minerals Management Service acknowledged receipt of OEDC Exploration & Production, L.P.'s (OEDC's) submittal of an Initial Joint Development Operations Coordination Document for Leases OCS-G 6397/6398, Destin Dome Blocks 1 and 2, Offshore, Alabama.

However, as stated in the subject letter, additional information is needed before the DOCD can be deemed submitted in accordance with 30 CFR 250.34(e). Therefore, enclosed is twenty-five (25) copies of the following information and data to be added to and made part of the previously submitted Environmental Assessment Report.

1. The produced hydrocarbons from Well No. 1 in Destin Dome Block 2 will flow full-well stream via a proposed 4-inch lease term pipeline to Caisson No. 1 where it will be combined with full-well stream production from Well No. 1, Destin Dome Block 1. The combined produced hydrocarbons from these two leases will then be transported via a proposed 8-inch right-of-way pipeline to OEDC's existing A platform in Mobile Block 960 for measurement and compression then onto the existing A platform in Mobile Block 959 for compression to sales line pressure and dehydration. The onshore terminal is located at Coden, Alabama. Approximately 10 MMCFPD of dry gas will be transported through the proposed pipelines.
2. OEDC will monitor the proposed unmanned facilities in accordance with Title 30 CFR 250.41 and Minerals Management Service's Notice to Lessees (NTL No. 96-1N). OEDC will perform pollution inspections bi-weekly. Additionally, OEDC's facilities in Destin Dome Blocks 1 and 2 will have continuous monitoring capabilities on the flowlines with the SCADA system located on OEDC's A platform in Mobile Block 959.

All pipelines will have pressure monitors (PSHL's) and all vessels and lines are monitored with PSHL's and/or LSHL's. Should the pressure and/or level fall out of range, the appropriate well will shut in. The SCADA system, which will report to the A platform on

Minerals Management Service
Leases OCS-G 6397/6398
Destin Dome Blocks 1 and 2
Environmental Assessment Report
November 6, 1996

Page 8

Should additional information be required please contact the undersigned or OEDC's regulatory agent, Cathy Thornton, J. Connor Consulting, Inc., at (713) 578-3388.

Sincerely,

OEDC EXPLORATION & PRODUCTION, L.P.

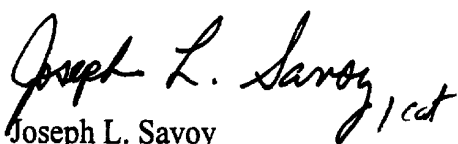
Handwritten signature of Joseph L. Savoy in cursive script.

Joseph L. Savoy
Vice President, Operations

BEST AVAILABLE COPY

JLS:CAT
Attachments

OEDC EXPLORATION & PRODUCTION, L.P.

September 21, 1996

Mr. Donald C. Howard
Regional Supervisor
Office of Field Operations
U.S. Department of the Interior
Minerals Management Service
1201 Elmwood Park Boulevard
New Orleans, LA 70123-2394



RE: Initial Joint Development Operations Coordination Document
Leases OCS-G 6397/6398, Destin Dome Blocks 1 and 2
OCS Federal Waters, Gulf of Mexico, Offshore, Alabama

Gentlemen:

In accordance with the provisions of Title 30 CFR 250.34, OEDC Exploration & Production, L.P. (OEDC) hereby submits for your review and approval twenty-five (25) copies of an Initial Joint Development Operations Coordination Document for Leases OCS-G 6397/6398, Destin Dome Blocks 1 and 2, Offshore, Alabama. Five (5) copies are "Proprietary Information" and twenty (20) copies are "Public Information".

Excluded from the Public Information copies are certain geologic discussions, depth of wells and structure map.

OEDC anticipates commencing activities under this proposed Initial Joint Development Operations Coordination Document on March 1, 1997.

Should additional information be required please contact the undersigned or OEDC's regulatory agent, Cathy Thornton, J. Connor Consulting, Inc., at (713) 578-3388.

Sincerely,

OEDC EXPLORATION & PRODUCTION, L.P.

A handwritten signature in cursive script that reads "Joseph L. Savoy, cat".

Joseph L. Savoy
Vice President, Operations

JLS:CAT
Enclosures

BEST AVAILABLE COPY

"Public Information"

OEDC EXPLORATION & PRODUCTION, L.P.

INITIAL JOINT DEVELOPMENT OPERATIONS COORDINATION DOCUMENT

DESTIN DOME BLOCKS 1 AND 2

LEASE OCS-G 6397/6398

OEDC Exploration & Production, L.P. (OEDC), as designated Operator of the subject lease, submits this proposed Initial Joint Development Operations Coordination Document in accordance with the regulations contained in Title 30 CFR 250.34 and more specifically defined in the Minerals Management Service Letters to Lessees and Operators dated October 12, 1988 and September 5, 1989.

BEST AVAILABLE COPY

HISTORY OF LEASE

Leases OCS-G 6397/6398 were acquired at the Eastern Gulf of Mexico Lease Sale No. 79 held on January 4, 1984. The leases were issued with an effective date of February 1, 1984 and expiration date of January 31, 1989. The subject leases are currently being held through January, 1997 by an approved Suspension of Production. OEDC will be submitting an additional request for a SOP with a revised activity schedule pending MMS' determination of the timing requirements for a DOCD in the Eastern Planning Area.

Under approved Plans of Exploration, Gulfstar Operating Company drilled and temporarily abandoned one well in each of the subject blocks. Lease OCS-G 6397, Well No. 1 was drilled to a total depth of 2000', tested and temporarily abandoned from a surface location at 5262' FSL & 5352' FEL of Destin Dome Block 1 on January 1, 1989. Lease OCS-G 6398, Well No. 1 was drilled to a total depth of 1800', tested and temporarily abandoned from a surface location at 5318' FSL & 206' FWL of Destin Dome Block 2 on January 27, 1989. In November, 1995, OEDC acquired the leases by virtue of a farm-in agreement with Apache Corporation.

In accordance with Letter to Lessees and Operators (LTL) dated November 5, 1993 which amends Title 30 CFR Part 256 surety bond requirements applicable to OCS lessees and operators, OEDC Exploration & Production, L.P. has submitted additional bonding to meet the \$3,000,000 areawide criteria.

SCHEDULE OF OPERATIONS

This proposed Initial Joint Development Operations Coordination Document provides for the completion of the existing temporarily abandoned wells, installation of a freestanding caisson over the surface location of each well and commencement of production.

The produced hydrocarbons from Well No. 1 in Destin Dome Block 2 will flow full-well stream via a proposed 4-inch lease term pipeline to Caisson No. 1 where it will be combined with full-well stream production from Well No. 1, Destin Dome Block 1. The combined produced hydrocarbons from these two leases will then be transported via a proposed 8-inch right-of-way pipeline to OEDC's existing A platform in Mobile Block 960 for processing.

A well location plat and table showing the surface and bottom hole location of the subject wells are included as Attachments A-1 and A-2.

Activities under this Initial Joint Development Operations Coordination Document for Destin Dome Blocks 1 and 2 are scheduled to commence on March 1, 1997.

The following schedule details the chronological order of the proposed events leading to the full start up of production.

<i>ACTIVITY</i>	<i>APPROXIMATE DATE</i>
1. Commence Tieback and Completion Operations on Lease OCS-G 6397, Well No. 1	March 1, 1997
2. Commence Tieback and Completion Operations on Lease OCS-G 6398, Well No. 1	March 15, 1997
3. Installation of Freestanding Caissons	April 1, 1997
4. Commence Installation of Pipelines	April 1, 1997
5. Hook-up and Commence Production	BEST AVAILABLE COPY June 1, 1997

DESCRIPTION OF PLATFORM

The proposed well protector structures will consist of freestanding caissons (Caisson No. 1) with a production deck, helideck and boatlanding. The proposed structure will be installed utilizing a jack-up rig while on location for completion operations. A typical schematic of the structure is included as Attachment B.

All hydrocarbon handling equipment installed for testing and production operations will be designed, installed and operated to prevent pollution from the proposed structure.

Mobile Block 959, will be capable of remotely shutting-in production, by shutting in all incoming pipelines at the boarding SDV. The satellite freestanding caissons each have their own independent safety system.

3. It is estimated that up to three (3) people will be utilized at the shore base (Dauphin Island, Alabama) in support of the proposed operations. The three (3) permanent employees will man the shore base. They will rotate on a 5-days on/2-days-off schedule.

It is estimated that additional employees will be required for supply boat, crew boat and standby operations. The vessel crews will not require local housing as they will usually live on their respective vessels while working in the area and will return to their residence upon completion of each tour of duty. Some deck hands may be hired from the local labor pool.

Some of the service firm employees may be hired locally. Most of these employees will return to their places of residence on their days off.

4. By letter dated May 1, 1996, Minerals Management Service approved OEDC's regional Oil Spill Contingency Plan (OSCP) annual update.

The OSCP covers all facilities operated by Offshore Energy Development Corporation, Dauphin Island Gathering Partners, OEDC Exploration and Production, L.P. and OEDC, Inc. in the offshore Gulf of Mexico, seaward of the coastline, under the jurisdiction of the Minerals Management Service.

In conducting oil and gas operations in the Gulf of Mexico, OEDC is committed to the prevention of pollution. The focus of OEDC's Spill Response Program is prevention. However, should an oil spill occur, this OSCP is designed to help company and contract employees respond quickly, safely and effectively to reduce damage to property and the environment. Response to an oil spill will require immediate notification to federal and state agencies. It will also require assembly of the Oil Spill Management Team, and possible mobilization of the Oil Spill Response Operating Team and spill response equipment.

OEDC is a member of Clean Gulf Associates. Through this association, all companies listed in OSCP have access to oil spill equipment along the gulf coasts of Louisiana, Alabama, Florida, Mississippi and Texas and would utilize this equipment along with all necessary third party services, as required for the cleanup of a major spill.

Pollution inspection are conducted on all unmanned facilities in accordance with MMS policies. Operations personnel have been instructed to check for pollution frequently during their tour of duty, and in the event pollution is spotted, to identify and shut off the source and make immediate notifications.

Pipeline leaks and rupture events are detectable through the monitoring of operating pressures by personnel at shorebases or producing facilities. Small leaks which may not be detectable through obvious declines in operating pressures are identified through aerial reconnaissance by aircraft or reports from pilots from other companies or patrols by marine vessels. If it is determined that the leaking line is OEDC's, the pipeline would be shut in and the Spill Response Coordinator or one of the Alternates would be contacted. The National Response Center, the Spill Management Team and other company personnel would be contacted and appropriated response actions started.

The Incident Commander and Alternates receive annual classroom training for familiarization with containment and recovery equipment, call-out procedures, the location and intended use of available response equipment, spill reporting procedures and deployment strategies. The Oil Spill Response Operating Team attends annual drills for familiarization with pollution control equipment or operations procedures. Additionally, a Spill Management Team tabletop exercise is also held on an annual basis.

5. OEDC is actively developing several leases in the Viosca Knoll, Destin Dome and Pensacola Areas. OEDC's objective is to develop the shallow miocene gas reservoirs. A multitude of other companies are developing reserves in the miocene, cretaceous and norphlet reservoirs in the Mobile and Viosca Knoll Areas.
6. In order to measure changes in environmental conditions and impacts in the geographic area, OEDC will monitor emissions from all rotary large horsepower compressors located on their platforms. Additionally, OEDC utilizes computer-aided lean burn natural gas powered equipment.

All discharges associated with the proposed activities will be in accordance with regulations implemented by Minerals Management Service (MMS), U. S. Environmental Protection Agency (EPA), and the U. S. Coast Guard (USCG).

Annex V of the International Convention for the Prevention of Pollution from ships, also known as MARPOL Protocol, prohibits the dumping of all plastic wastes.

Destin Dome Blocks 1 and 2 are located in EPA Region IV. The NPDES General Permit GMG 280000 was only extended for those operators who had requested coverage prior to the expiration date of the permit. By letter dated August 3, 1995, Apache Corporation transferred permit responsibility, coverage and liability to OEDC. Therefore, the operations in Destin Dome Blocks 1 and 2 are covered under the existing NPDES General Permit GMG 280000.

Discharges will contain no free oil and will be in compliance with and monitored as required by the permit. Any drilling fluid contaminated with oil will be transported to shore for proper disposal at an authorized disposal site.

Solid domestic wastes will be transported to shore for proper disposal at an authorized disposal site, and sewage will be treated on location by U. S. Coast Guard approved marine sanitation devices.

7. OEDC has considered several alternatives to reduce the risk of environmental impacts caused by the development and production of these shallow gas reservoirs. None of these alternatives are technically feasible at this time. OEDC feels that the proposed plans would cause minimal environmental impact.
8. Air temperatures have annual means of 19°C at Mobile and 20°C at Cape San Blas. The winter mean temperatures, seasonal low, are 12°C at Mobile and 14°C at Cape San Blas; summer mean temperatures, seasonal highs, are 25°C and 26°C respectively. The annual mean temperature at Pensacola, Florida is 19.9°C. It is important to remember that extreme temperatures and barometric pressures do occur that depart considerably from their mean values. (Florida A&M University, 1988).

Average annual precipitation along the NEGOM between New Orleans, Louisiana and Fort Myers, Florida is approximately 137 cm. The average annual precipitation at Pensacola, Florida is 1.55 m. Rainfall is fairly evenly distributed throughout the year, with the greatest amounts occurring during June, July, and August when the winds are predominantly out of the south and southeast.

Precipitation is frequent and abundant throughout the year but does show distinct seasonal variation. Stations along the coast record the highest precipitation values during the warmer months of the year. The warmer months usually have convective cloud systems that produce showers and thunderstorms; however, these thunderstorms rarely cause any damage or have

attendant hale (USDOC, 1967; Brower et al., 1972). The month of maximum rainfall for most locations is July. Winter rains are associated with the frequent passage of frontal systems through the area. Rainfalls are generally slow, steady, and relatively continuous, often lasting several days. Snowfalls are rare, and when frozen precipitation does occur, it usually melts on contact with the ground. Incidence of frozen precipitation decreases with distance offshore and rapidly reaches zero.

Warm, moist Gulf air blowing slowly over chilled land or water surfaces brings about the formation of fog. Fog occurrence decreases seaward, but visibility has been less than 800 M due to offshore fog. Coastal fogs generally last 3 or 4 hours, although particularly dense sea fogs may persist for several days. The poorest visibility conditions occur during winter and early spring. The period from November through April has the lowest visibility. The number of days that visibility decreases to less than 400 m (heavy fog) in the Eastern Gulf decreases from 35 days/year in Pensacola to 1 day/year at Key West.

Prevailing winds in this region are from a southerly direction in spring and summer. During fall and winter, wind direction is mostly from a northerly direction because of the influence of cold fronts. These fronts tend to come at one to three day intervals. After the frontal passage, winds return to the prevailing southerly direction. On average, the summer speeds are lower than the winter speeds. Because of the greater speed of the northerly winds, the resultant wind velocity factor is from the north. Significant deviations from this pattern occur during tropical and extra tropical storms (Wolfe et al., 1988).

The Gulf of Mexico is part of the Atlantic tropical cyclone basin. Tropical cyclones generally occur in summer and fall seasons; however, the Gulf also experiences winter storms or extratropical storms. These winter storms generally originate in middle and high latitudes and have winds that can attain speeds of 15-266 m/sec (11.2-58.2 mph). The Gulf is an area of cyclone development during cooler months due to the contrast of the warm air over the Gulf waters and the cold continental air over the United States. Cyclogenesis or formation of extratropical cyclones in the Gulf of Mexico is associated with frontal overrunning (Hsu, 1992). The most severe extratropical storms in the Gulf originate when a cold front encounters the jet stream over the warm waters of the Gulf. Statistics of 100-year data of extratropical cyclones reveal that most activity occurs above 25°N in the western Gulf of Mexico. The mean number of these storms ranges from 0.9 near the southern tip of Florida to 4.2 over central Louisiana (USDOI, MMS, 1988). The Minerals Management Service's LATEX study contains an element to study the generation of extratropical storms in the Gulf.

The frequency of cold fronts in the Gulf exhibits similar patterns during the four-month period of December through March. During this time the area of frontal influence reaches 10°N. Frontal frequency is about none fronts per month in February and about seven fronts per month in March. By May, the frequency decreases to about four fronts per month and the region of frontal influence retreats to about 15°N. During June-August frontal activity decreases to almost zero and fronts seldom reach below 25°N. (USDOI, MMS, 1988).

Tropical cyclones originate over the warm waters of the central Atlantic Ocean, Caribbean Sea or the Gulf of Mexico. From a climatic point of view, tropical storms provide a mechanism for transporting heat and water vapor from the tropics to midlatitudes. These storms are classified by the U.S. National Weather Service according to intensity. Tropical storms have wind speeds greater than 16 m/sec (35.8 mph); storms with wind speeds greater than 32 m/sec (71.6 mph) are called hurricanes. Tropical cyclones occur most frequently between June and November. Based on 42 years of data, there are 9.9 storms per year with 5.5 of those becoming major hurricanes in the Atlantic Ocean (Gray, written communication, 1992). Data from 1886 to 1986 show that 44.5 percent of the storms originating in the Atlantic basin, or 3.7 storms per year, will affect the Gulf of Mexico (USDOI, MMS, 1988). The same data, however, show that the storm activity affecting the Gulf has decreased over the past 40-45 years. The number of hurricanes directly hitting the Gulf States are as follows: Florida, 54; Alabama, 10; Mississippi, 8; and Louisiana, 24. (Hebert et al, 1992).

Visual No. 7 of the Final EIS for Sales 131, 135, and 137 shows the highest probabilities of at least one storm per season to be in the southern tip of Florida and west of the Mississippi River delta to Port Arthur, Texas. The coastline between Mississippi and west Florida also has areas of high probability for a hurricane hit.

9. In June, 1996, OEDC contracted SpillNet, Inc. to provide environmental sensitive areas of the shorelines that may be affected by the proposed operations. Environmental Sensitivities Maps 1 through 8 are included as Attachment A.
10. The public hearings of OCS Sale 79 were held in Mobile, Alabama, on October 6, 1982, where no one testified, and in Tampa, Florida, on October 7, 1982, where 18 persons testified. A total of 89 letters were received by the MMS regarding OCS Sale 79. The State of Florida's concerns discussed during the public hearing for OCS Sale 79 were as follows: (1) coastal related tourist economy, (2) coastal recreation, (3) commercial fishing and related coastal and offshore ecosystems, (4) endangered and threatened wildlife (manatees and sea turtles), and (5) designated environmentally unique, sensitive, and/or important areas. More

recently, public comments regarding the MMS' proposed 5-year OCS oil and gas program for years 1997 - 2002 were predominantly negative toward drilling and production off the Florida coast. The Governor of the State of Florida voiced opposition to drilling and production off that coast. Over 98 percent of individual comments received from Florida residents, and 60 percent of the signatures on various petitions received by the MMS for Eastern Gulf of Mexico Sale 137 opposed oil and gas leasing (USDOJ, MMS, 1990).

Public opinion in Alabama differs to some degree from that expressed by the State of Florida. In comments on the 5-year program for years 1997- 2002, the Governor of the State of Alabama expressed concern Over revenue allocation from OCS production. A soon to be completed MMS-funded study found that concerns about OCS development were greater east of Mobile Bay, in those portions of Alabama more closely associated with coastal tourism, that was the case in areas of wester Alabama, Louisiana, or Mississippi (cf Gramling in USDOJ, MMS, 1994).

11. With the installation of minimal freestanding caissons and the utilization of existing facilities, OEDC's proposed development operations will have little or no effect on the general weather patterns.
12. OEDC's proposed development operations will have little or no effect on sea temperature, currents, tides, sea state, water depth, etc.
13. Copies of the Initial Joint Development Operations Coordination Document will be submitted to the Florida's Governors Office and the Alabama Department of Environmental Management to be published for public notice. OEDC will work diligently to adequately answer the concerns from the notices.
14. A copy of a Field Layout with OEDC's existing and proposed pipelines located in the NEGOM in included as Attachment B.

As a prudent operator, OEDC Exploration & Production, L.P. will conduct its operations in accordance with the provisions specified in Minerals Management Service Notice to Lessees 83-03 in order to avoid all pipelines and/or cables in the vicinity of the proposed operations.

15. OEDC believes that no adverse unavoidable impacts will result from the operations proposed in this Initial Joint Development Operations Coordination Document.

88°48'0"

88°42'0"

88°36'0"

Environmental Sensitivities Overview Map

30°30'0"

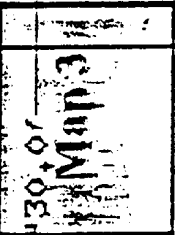

Map 3

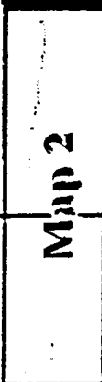

Map 2

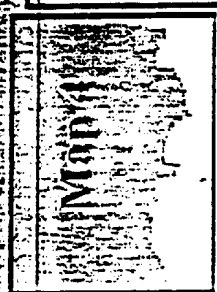

Map 4

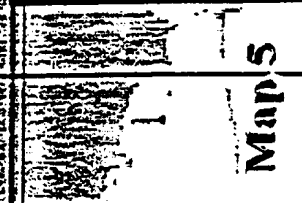

Map 5

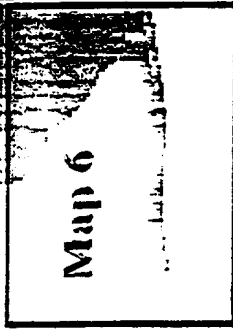

Map 6

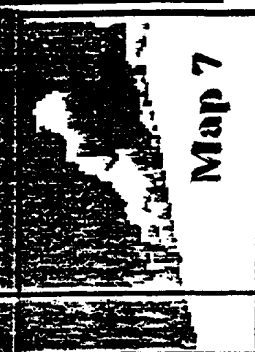

Map 7

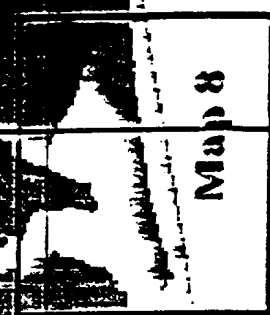

Map 8

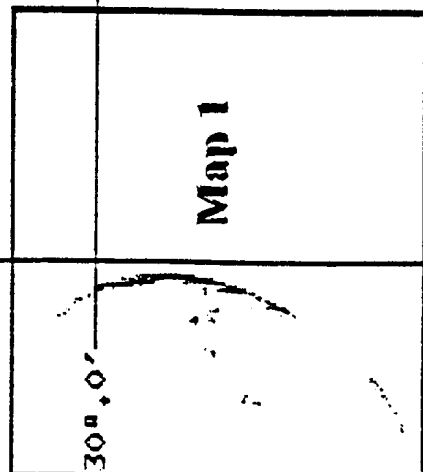

Map 1

30°30'0"

29°30'0"

GULF OF MEXICO

BEST AVAILABLE COPY

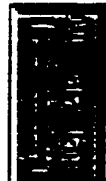

89° 0'

88° 48.0'

88° 36.0'

88° 24.0'

Environmental Sensitivities Map 1

ENVIRONMENTAL SENSITIVITIES KEY
 REFERENCE: U.S. FISH & WILDLIFE

- Reefs
- Fish
- Invertebrates
- Reptiles & Amphibians
- Mammals
- Raptors
- Seabirds
- Shorebirds
- Songbirds
- Wading Birds
- Waterfowl
- Plants

MORRIS ENVIRONMENTAL, INC.

CHANDELEUR ISLANDS

BRETON NHR

BRETON NHR

BRETON NHR

E. SIDE OF CHAN. IS.

BRETON NHR

BRETON NHR

BRETON NHR

E. OF CHANDELEUR IS.

BRETON NWR

GRAND BASSIER IS.

BEST AVAILABLE COPY

SE OF CHANDELEUR IS.

E. OF CURFEW ISLAND



GULF OF MEXICO

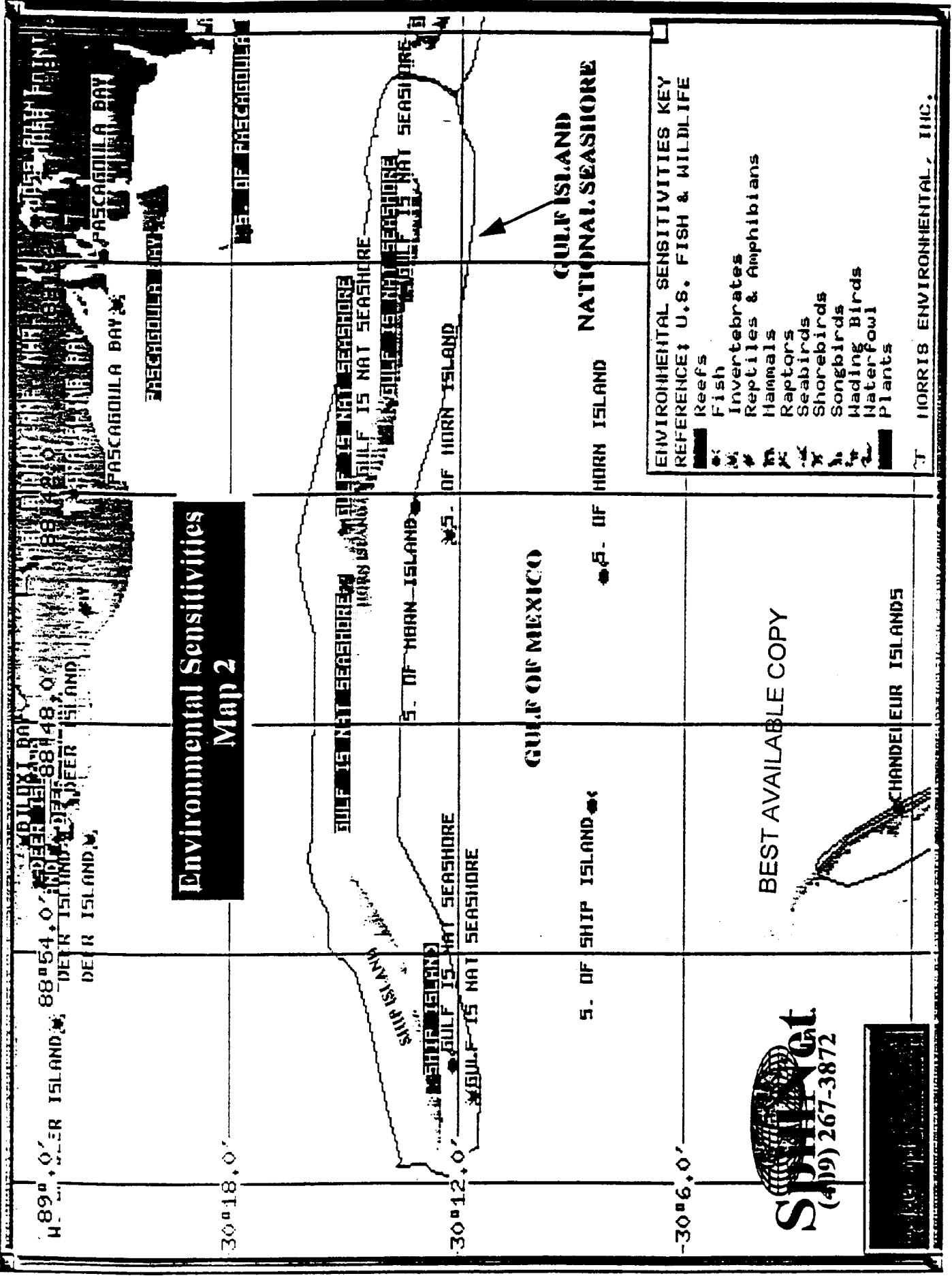

Environmental Sensitivities Map 2

- ENVIRONMENTAL SENSITIVITIES KEY
 REFERENCE: U.S. FISH & WILDLIFE
- Reefs
 - Fish
 - Invertebrates
 - Reptiles & Amphibians
 - Mammals
 - Raptors
 - Seabirds
 - Shorebirds
 - Wading Birds
 - Waterfowl
 - Plants

HARRIS ENVIRONMENTAL, INC.

Sprint
 (419) 267-3872

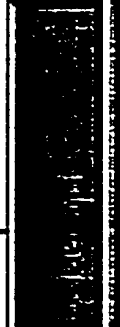

88°66.4'

88°52.8'

ENVIRONMENTAL SENSITIVITIES KEY
REFERENCE: U.S. FISH & WILDLIFE

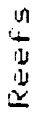
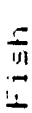
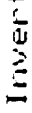
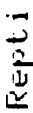
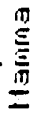
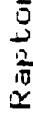
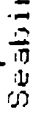
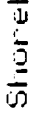
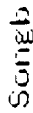
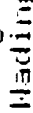
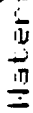
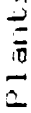
-  Reefs
-  Fish
-  Invertebrates
-  Reptiles & Amphibians
-  Mammals
-  Raptors
-  Seabirds
-  Shorebirds
-  Songbirds
-  Nesting Birds
-  Waterfowl
-  Plants

BEST AVAILABLE COPY

HORRIS ENVIRONMENTAL, INC.

Environmental Sensitivities
Map 3

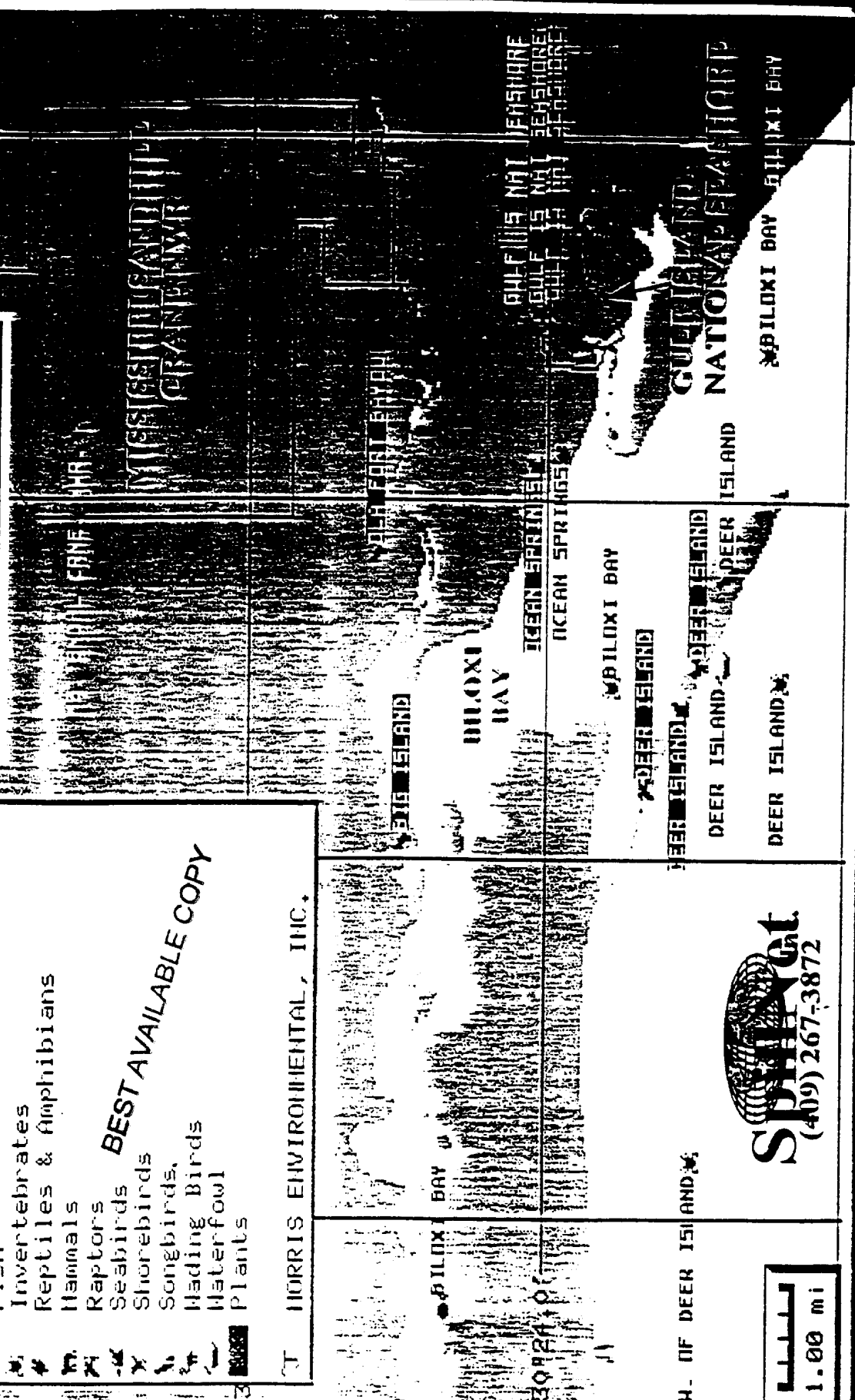

1.00 mi

Environmental Sensitivities Map 4

ENVIRONMENTAL SENSITIVITIES KEY
REFERENCE: U.S. FISH & WILDLIFE

XXXXX Reefs

○ Fish

□ Invertebrates

■ Reptiles & Amphibians

□ Mammals

□ Raptors

□ Seabirds

□ Shorebirds

□ Songbirds

□ Migrating Birds

□ Waterfowl

□ Plants

BEST AVAILABLE COPY

J MORRIS ENVIRONMENTAL, INC.

88°42' 0"

88°36' 0"

88°30' 0"

30°28' 8"

30°24' 0"

30°19' 2"

MISSISSIPPI SANDHILL CRANE NWR

MISSISSIPPI SANDHILL CRANE NWR

MISSISSIPPI SANDHILL CRANE NWR

PASCAGOULA BAY NWR

PASCAGOULA BAY NWR

PASCAGOULA BAY NWR

PASCAGOULA BAY NWR

PASCAGOULA BAY NWR

PASCAGOULA BAY NWR

PASCAGOULA BAY NWR

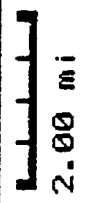

MISSISSIPPI SANDHILL CRANE NWR

PASCAGOULA BAY NWR

PASCAGOULA BAY NWR

PASCAGOULA BAY NWR

PASCAGOULA BAY NWR

PASCAGOULA BAY NWR

MISSISSIPPI SANDHILL CRANE NWR

MISSISSIPPI SANDHILL CRANE NWR

MISSISSIPPI SANDHILL CRANE NWR

MISSISSIPPI SANDHILL CRANE NWR

MISSISSIPPI SANDHILL CRANE NWR

MISSISSIPPI SANDHILL CRANE NWR

MISSISSIPPI SANDHILL CRANE NWR

MISSISSIPPI SANDHILL CRANE NWR

MISSISSIPPI SANDHILL CRANE NWR

MISSISSIPPI SANDHILL CRANE NWR

MISSISSIPPI SANDHILL CRANE NWR

MISSISSIPPI SANDHILL CRANE NWR

MISSISSIPPI SANDHILL CRANE NWR

PASCAGOULA BAY NWR

PASCAGOULA BAY NWR

PASCAGOULA BAY NWR

PASCAGOULA BAY NWR

PASCAGOULA BAY NWR

Environmental Sensitivities Map 5

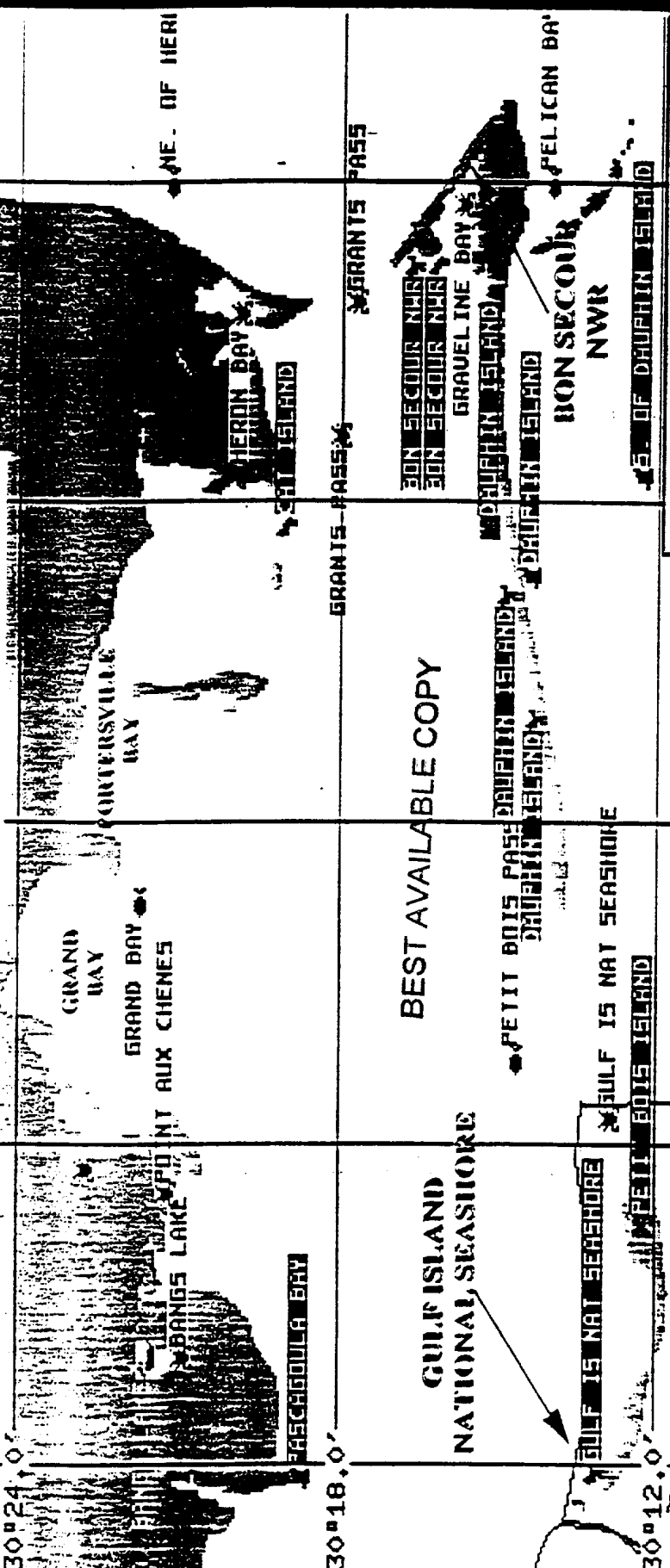

ENVIRONMENTAL SENSITIVITIES KEY
 REFERENCE: U.S. FISH & WILDLIFE

- Reefs
- Fish
- Invertebrates
- Reptiles & Amphibians
- Mammals
- Raptors
- Seabirds
- Shorebirds
- Songbirds
- Migrating Birds
- Waterfowl
- Plants

J MORRIS ENVIRONMENTAL, INC.

BEST AVAILABLE COPY

GULF OF MEXICO

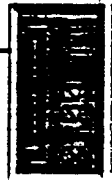

30°24.0'

06° 00'

07° 54.0'

Environmental Sensitivities Map 6

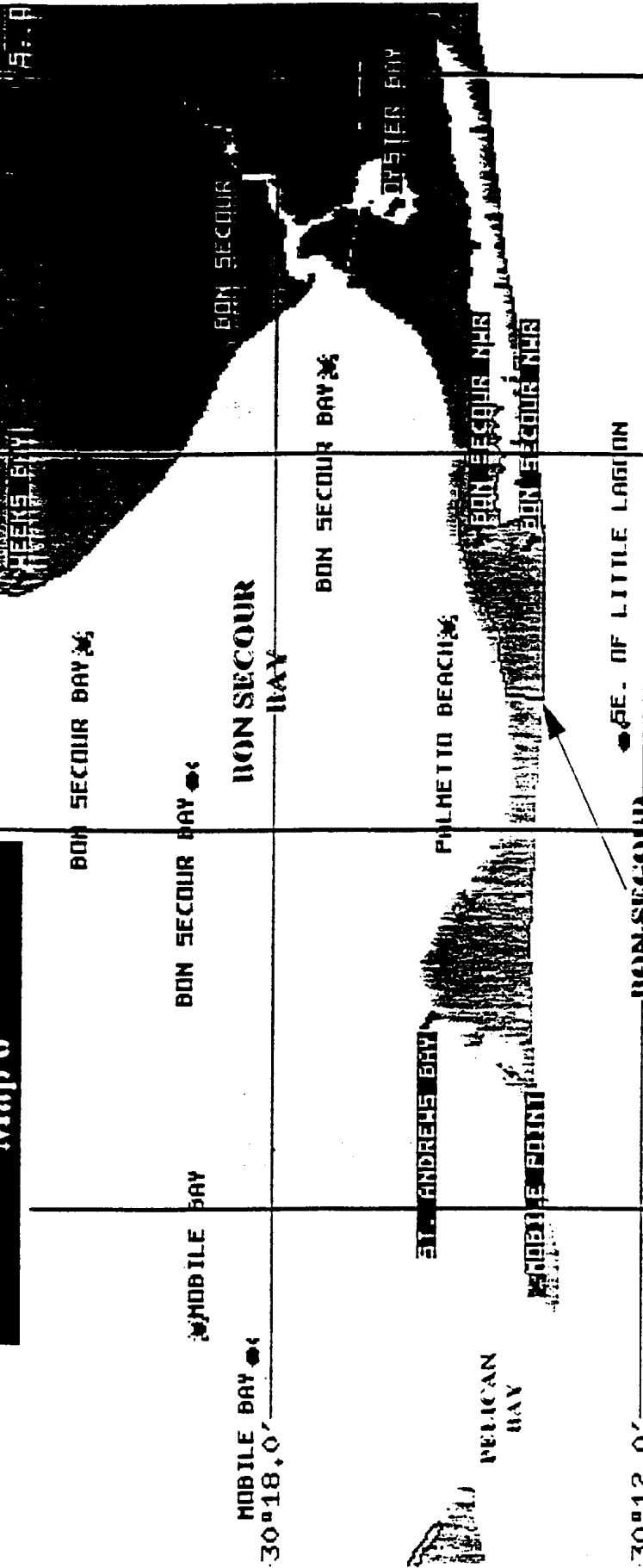

30°12.0'

BON SECOUR
NWR

SE. OF LITTLE LAGOON

BEST AVAILABLE COPY

GULF OF MEXICO

ENVIRONMENTAL SENSITIVITIES KEY
REFERENCE: U.S. FISH & WILDLIFE

■	Reefs
○	Fish
⊗	Invertebrates
#	Reptiles & Amphibians
△	Mammals
✈	Raptors
✎	Seabirds
✎	Shorebirds
✎	Songbirds
✎	Migrating Birds
✎	Waterfowl
■	Plants

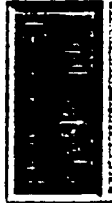

State
(409) 267-3872

J MORRIS ENVIRONMENTAL, INC.

Environmental Sensitivities Map 7

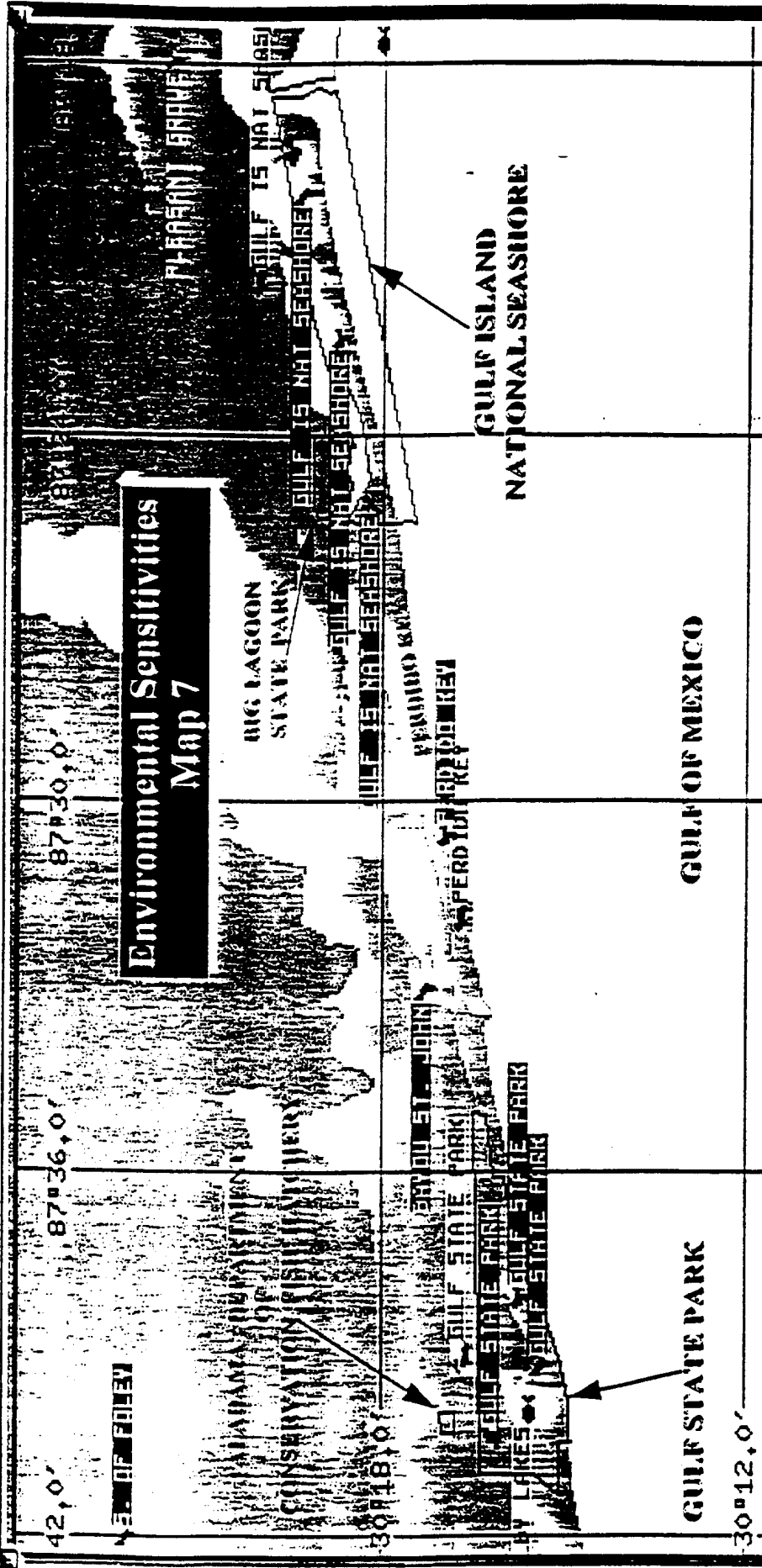

ENVIRONMENTAL SENSITIVITIES KEY
REFERENCE: U.S. FISH & WILDLIFE

- Reefs
- Fish
- Invertebrates
- Reptiles & Amphibians
- Mammals
- Raptors
- Seabirds
- Shorebirds
- Songbirds
- Wading Birds
- Waterfowl
- Plants

MORRIS ENVIRONMENTAL, INC.

BEST AVAILABLE COPY



Environmental Sensitivities
Map 8

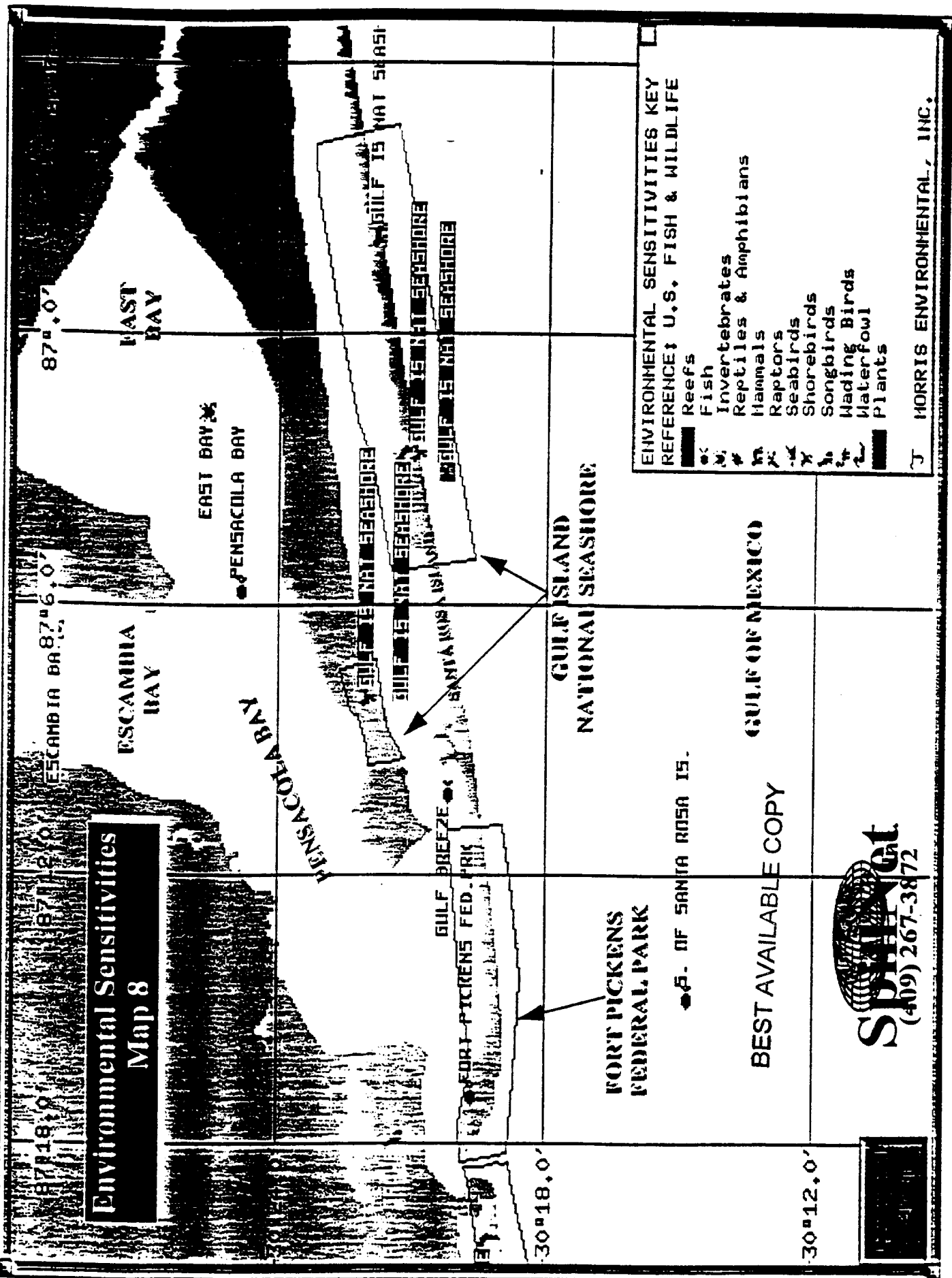

- ENVIRONMENTAL SENSITIVITIES KEY**
REFERENCE: U.S. FISH & WILDLIFE
- Reefs
 - Fish
 - Invertebrates
 - Reptiles & Amphibians
 - Mammals
 - Raptors
 - Seabirds
 - Shorebirds
 - Songbirds
 - Migrating Birds
 - Waterfowl
 - Plants

• IS. OF SANTA ROSA IS.

BEST AVAILABLE COPY



J MORRIS ENVIRONMENTAL, INC.

GENERAL NOTES

LEGEND

- EXISTING PIPELINES
- - - - - PROPOSED PIPELINES
- - - - - EXISTING FUTURE PIPELINES
- - - - - PROPOSED FUTURE PIPELINES

BEST AVAILABLE COPY

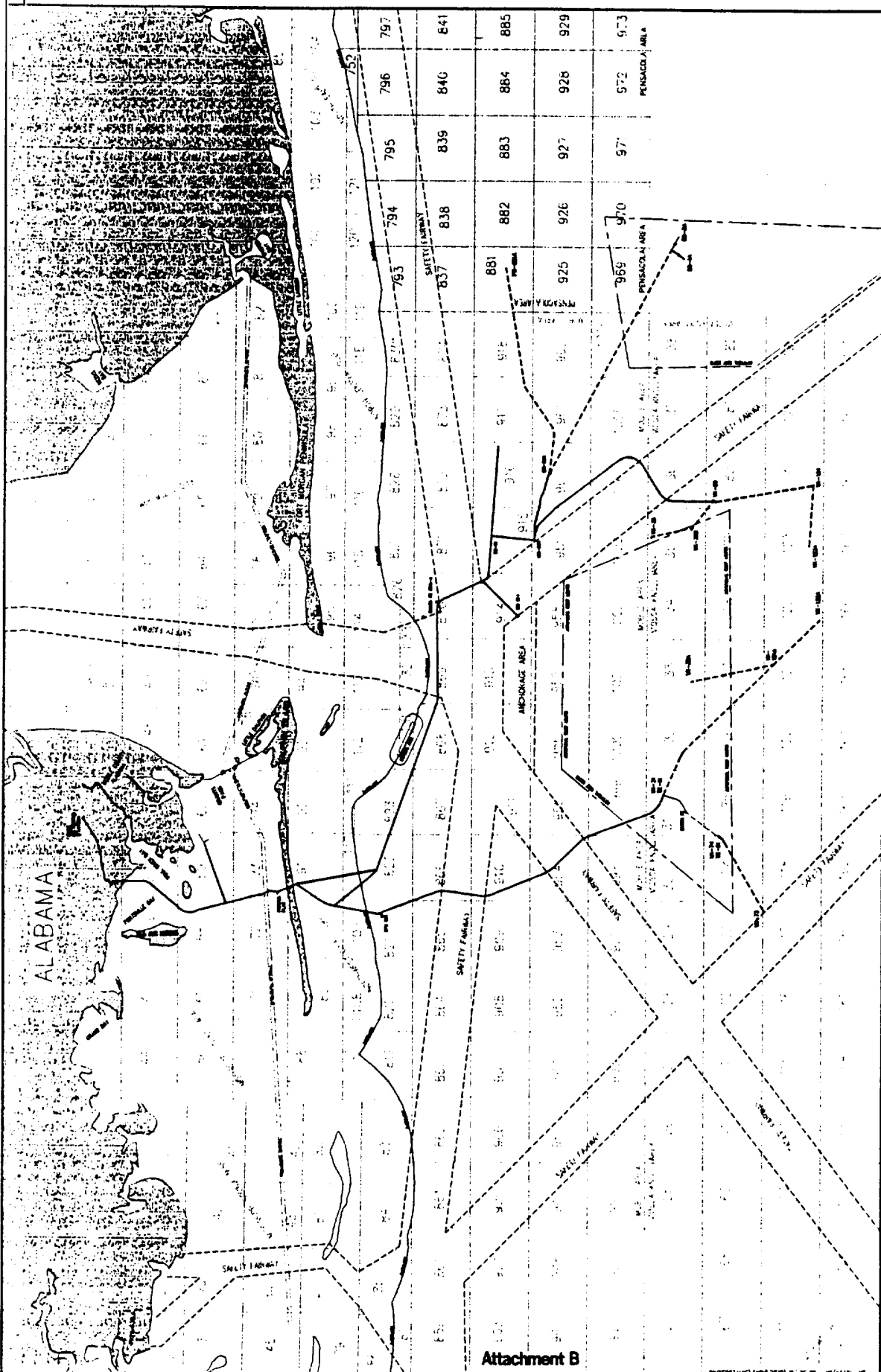

NO.	DATE	BY	DESCRIPTION
1	04/18/04
2
3
4
5
6
7
8
9
10
11
12
13
14
15
16
17
18
19
20
21
22
23
24
25
26
27
28
29
30
31
32
33
34
35
36
37
38
39
40
41
42
43
44
45
46
47
48
49
50
51
52
53
54
55
56
57
58
59
60
61
62
63
64
65
66
67
68
69
70
71
72
73
74
75
76
77
78
79
80
81
82
83
84
85
86
87
88
89
90
91
92
93
94
95
96
97
98
99
100

MPC INTERNATIONAL, Inc.
Houston, Texas

OFFSHORE ENERGY DEV. CORP. / BALTIMORE ISLAND GATHERING PART
CDDC / DOP PIPELINE PROJECTS
FIELD LAYOUT WITH EXISTING & PROPOSED PIPELINES

DATE: 04/18/04
SCALE: 1"=12.00'
SHEET NO.: 54-F1-09F

OEDC EXPLORATION & PRODUCTION, L.P.



October 8, 1996

Mr. Donald C. Howard
Regional Supervisor
Office of Field Operations
U.S. Department of the Interior
Minerals Management Service
1201 Elmwood Park Boulevard
New Orleans, LA 70123-2394

BEST AVAILABLE COPY

RE: Initial Joint Development Operations Coordination Document, Control No. N-5543, Leases OCS-G 6397/6398, Destin Dome Blocks 1 and 2, OCS Federal Waters, Gulf of Mexico, Offshore, Alabama

Gentlemen:

By letter dated September 21, 1996, OEDC Exploration & Production, L.P. (OEDC) submitted for your review and approval an Initial Joint Development Operations Coordination Document for Leases OCS-G 6397/6398, Destin Dome Blocks 1 and 2, Offshore, Alabama.

Enclosed is twenty-five (25) copies of additional data you requested to be added to and made part of the existing Plan. The subject wells will be tied back and completed utilizing a typical jack-up drilling rig (i.e., Marine 225). When a rig is selected, the rig specifications will be made a part of the Sundry Notice-Intent with the proposed completion procedure. See the attached rig specifications for a typical rig (Marine 225) which may be utilized for the proposed completion operations.

Safety features will include well control and blowout prevention equipment as described in Title 30 CFR 250.50. The appropriate life rafts, life jackets, ring buoys, etc., as prescribed by the U. S. Coast Guard will be maintained on the facility at all times.

The existing wells were perforated and left temporarily abandoned with approximately 80 bbls of 9.2 ppg saltwater brine. OEDC plans to drill out the plugs, tieback the casings to surface then displace the existing brine from the wells discharging it overboard. As required by the EPA, monthly and end-of-well LC50 toxicity tests will be performed on all discharges into OCS Federal Waters. OEDC does not anticipate any additional discharges associated with these proposed operations.

Supplement to Initial Joint DOCD
Leases OCS-G 6397/6398
Destin Dome Blocks 1 and 2
October 8, 1996

Page Two

Should additional information be required please contact the undersigned or OEDC's regulatory agent, Cathy Thornton, J. Connor Consulting, Inc., at (713) 578-3388.

Sincerely,

OEDC EXPLORATION & PRODUCTION, L.P.

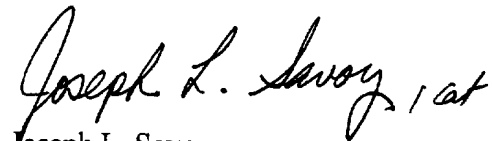
A handwritten signature in cursive script that reads "Joseph L. Savoy, cat".

Joseph L. Savoy
Vice President, Operations

BEST AVAILABLE COPY

JLS:CAT
Enclosures



UNITED STATES OF AMERICA
DEPARTMENT OF TRANSPORTATION
UNITED STATES COAST GUARD

CERTIFICATION DATE 19OCT95

EXPIRATION DATE 19OCT97

Certificate of Inspection

EX: MARINE 1

VESSEL NAME MARINE 225		OFFICIAL NUMBER D523782	CALL SIGN WBT3948	SERVICE MODU	
HOME PORT NATL VESSEL DOC CTR		HULL MATERIAL STEEL	HORSEPOWER	PROPULSION	
PLACE BUILT BEAUMONT TX	DATE BUILT 01JAN69	GROSS TONS 4889	NET TONS 4889	DWT	LENGTH 210.10
OWNER MARINE DRILLING MANAGEMENT CO ONE SUGAR CREEK CTR BLVD SUITE 600 SUGAR LAND, TX 77478-3556			OPERATOR MARINE DRILLING MANAGEMENT CO ONE SUGAR CREEK CTR BLVD SUITE 600 SUGAR LAND, TX 77478-3556		

THIS VESSEL MUST BE MANNED WITH THE FOLLOWING LICENSED AND UNLICENSED PERSONNEL, INCLUDED IN WHICH THERE MUST BE 2 CERTIFICATED LIFEBOATMEN AND 0 CERTIFICATED TANKERMAN.

___ MASTER	___ MASTER & 1ST CLASS PILOT	<u>2</u> ABLE SEAMEN	___ CHIEF ENGINEER	___ FIREMEN-WATERTENDERS
___ CHIEFMATE	___ CLASS PILOT	<u>1</u> ORDINARY SEAMEN	___ 1ST ASST. ENGINEER	___ OILERS
___ 2ND MATE	___ RADIO OFFICER(S)	___ DECKHANDS	___ 2ND ASST. ENGINEER	___
___ MATES	___ OPERATOR(S)	___	___ ENGR'S.	___

OTHER REQUIRED CREW 1 OFFSHORE INSTALLATION MANAGER

IN ADDITION, THIS VESSEL MAY CARRY 0 PASSENGERS, OTHER PERSONS IN CREW, PERSONS IN ADDITION TO CREW, AND **44 INDUSTRIAL PERSONNEL**. TOTAL PERSONS ALLOWED: 48

ROUTE PERMITTED AND CONDITIONS OF OPERATION:

OCEANS

LIMITED TO THE GULF OF MEXICO, NOT ON AN INTERNATIONAL VOYAGE.

CERTIFICATED IN ACCORDANCE WITH NVIC 4-78, CHANGE 1.

SPECIAL STEELS USED IN CONSTRUCTION, REFER TO CONSTRUCTION PORTFOLIO PRIOR TO INITIATING ANY REPAIRS.

BEST AVAILABLE COPY

PRESSURE VESSELS

TYPE	LOCATION	NEXT EXAM	LAST EXAM	PRIOR EXAM
AIR RECEIVER	MACHINERY SPACE	21OCT96	21OCT93	
AIR RECEIVER	MACHINERY SPACE	21OCT96	21OCT93	
AIR RECEIVER	DRILL FLOOR	21OCT96	21OCT93	
DRY BULK	DECK	21OCT96	21OCT93	
DRY BULK	DECK	21OCT96	21OCT93	
DRY BULK	DECK	21OCT96	21OCT93	

*** SEE NEXT PAGE FOR ADDITIONAL CERTIFICATE INFORMATION ***

WITH THIS INSPECTION HAVING BEEN COMPLETED AT **GULF OF MEXICO (SS 158)** ON **19OCT95**, THIS VESSEL IS CERTIFIED BY THE OFFICER IN CHARGE, MARINE INSPECTION, **MORGAN CITY, LOUISIANA**, TO BE IN ALL RESPECTS IN CONFORMITY WITH THE APPLICABLE VESSEL INSPECTION LAWS AND THE RULES AND REGULATIONS PRESCRIBED THEREUNDER.

PERIODIC REINSPECTIONS

DATE	ZONE	SIGNATURE

THIS CERTIFICATE ISSUED BY

M. B. Slack
M. B. SLACK, CAPTAIN, USCG

OFFICER IN CHARGE, MARINE INSPECTION

MORGAN CITY, LOUISIANA

INSPECTION ZONE



Certificate of Inspection

MARINE 225

PAGE 2

CERTIFICATION DATE: 19OCT95

--- HULL EXAMS ---

-EXAM TYPE-	-NEXT EXAM-	-LAST EXAM-	-PRIOR EXAM-
DRYDOCK	21OCT96	21OCT93	
INTERNAL STRUCTURAL	21OCT96	21OCT93	

--- STABILITY ---

LETTER BOOK APPROVAL DATE/ 04MAR88 OFFICE/ GMSC

--- INSPECTION STATUS ---

BEST AVAILABLE COPY

PRESSURE VESSELS

TYPE	LOCATION	LAST	NEXT
DRY BULK	DECK	21OCT93	21OCT96
DRY BULK	DECK	21OCT93	21OCT96
DRY BULK	DECK	21OCT93	21OCT96
AIR RECEIVER	MACHINERY SPACE	21OCT93	21OCT96
AIR RECEIVER	MACHINERY SPACE	21OCT93	21OCT96
AIR RECEIVER	DRILL FLOOR	21OCT93	21OCT96

LIFESAVING

LIFEBOAT/RAFT IDENTIFICATION	SERVICED/REFURBISHED	WEIGHT TEST	FALLS RENEWED	FALLS END/END
1	19OCT95	19OCT95	31JUL88	
2	19OCT95	19OCT95	31JUL88	
25 PERSON LIFERAFT	11OCT95	19OCT95		
25 PERSON LIFERAFT	14OCT95	19OCT95		

--- LIFESAVING EQUIPMENT ---

NUMBER PERSONS		REQUIRED
TOTAL EQUIPMENT FOR	48	LIFE PRESERVERS (ADULT)...
LIFEBOATS (TOTAL).....	2	56 LIFE PRESERVERS (CHILD)...
LIFEBOATS (PORT)*.....	1	28 RING BUOYS (TOTAL).....
LIFEBOATS (STARBD)*...	1	28 WITH LIGHTS*.....
MOTOR LIFEBOATS*.....	2	2 WITH LINE ATTACHED*....
LIFEBOATS W/RADIO*...		2 OTHER*.....
RESCUE BOATS/PLATFORMS.		IMMERSION SUITS.....
INFLATABLE RAFTS.....	2	50 PORTABLE LIFEBOAT RADIOS.
LIFE FLOATS/BUOYANT APP		EQUIPPED WITH EPIRB?.....
WORKBOATS (NOT REQUIRED)		NO (* INCLUDED IN TOTALS)

--- FIRE FIGHTING EQUIPMENT ---

TOTAL HOSE LENGTH/ 500 NUMBER OF FIRE AXES/ 2 NUMBER OF FIRE PUMPS/ 2

FIXED EXTINGUISHING SYSTEMS

SPACE PROTECTED	AGENT	CAPACITY
PAINT LOCKER	CO2	150

*** SEE NEXT PAGE PLEASE ***



DEPARTMENT OF TRANSPORTATION
UNITED STATES COAST GUARD

Certificate of Inspection

MARINE 225

PAGE 3

CERTIFICATION DATE: 19OCT95

FIRE EXTINGUISHERS - HAND PORTABLE AND SEMI-PORTABLE
2 A-II B-I 10 B-II B-III
 B-IV 2 B-V 2 C-I 4 C-II

*** END ***

BEST AVAILABLE COPY

Marine 225

BETHLEHEM JU 225 MAT SUPPORTED JACKUP

WATER DEPTH RATINGS:

Non-Hurricane: 225'
Hurricane: 175'
Minimum Depth: 23'

LEG LENGTH: 287' long

DRILLING CAPACITY: 20,000'

FLAG: U.S.A.

CERTIFICATION: ABS + A-1
Classification

QUARTERS CAPACITY: 48 persons

YEAR BUILT: 1969

YEAR RECONDITIONED: 1993

DIMENSIONS:

BARGE: 176' long x 109'
wide x 16' deep

MAT: 210' long x 170'
wide x 12' deep
(including 2' scour
skirt)

DRILLING SLOT: 58' long x 50' wide

SLOT IN MAT: 87' long x 90' wide

HELICOPTER DECK: 60' x 60', designed
for Sikorsky 61

LOADS:

Lightship Weight: 18,622 kips

Drilling & Stand
by Variable: 4,500 kips

Storm Survival Variable: 3,000 kips

Maximum Jacking
Variable: 2,000 kips

Hook Load Variable: 750 kips

Rotary Load Variable: 750 kips

CAPACITIES:

Drill Water: 4,484 bbls

Potable Water: 472 bbls

Fuel Oil: 1,796 bbls

Active Mud: 1,500 bbls

Bulk Materials: 3,900 cu ft

Bulk Cement: 4,050 cu ft

Sack Storage: 3,000 sacks

BEST AVAILABLE COPY

BEST AVAILABLE COPY

MARINE 225
EQUIPMENT INVENTORY

DRILLING VESSEL DESCRIPTION: Bethlehem JU 225 MS mat supported self-elevating drilling unit. Built in 1969. Classed as an A-1 Self-Elevating Mobile Drilling Unit.

DESIGN OPERATING CONDITIONS:

Maximum water depth (non-hurricane):	225'
Maximum water depth (hurricane):	175'
Minimum water depth:	23'
Drilling depth capacity:	20,000'

DIMENSIONS:

Length overall:	176'
Breadth:	109'
Depth of Hull:	16'
Mat length:	210'
Mat width:	170'
Mat depth:	10'
Length of Legs (including mat):	252'

**MAX. OPERATING/ENVIRONMENTAL
CONDITIONS:**

Drilling:

Drilling load (kips)	4,500
Wind speed (knots)	100
Wave height (ft)	35

Storm Survival:

Variable load (kips)	3,000
Wind speed (knots)	100
Wave height (ft)	50

RIG STORAGE CAPACITIES:

Drill Water:	4,848 bbls
Potable Water:	402 bbls
Fuel:	1,796 bbls
Liquid Mud:	1,500 bbls
Bulk Mud:	3,900 cu ft
Bulk Cement:	4,050 cu ft
Sack Material:	3,000 sacks

DRAWWORKS:

National 1320 M double drum. Baylor model 6032 auxiliary electric brake, powered by two Caterpillar model D-399 turbocharged diesel engines.

DERRICK:

Continental Emsco Model 20R Derrick, 147' clear height by 30' base. 1,400,000 lbs. gross nominal rating.

MUD PUMPS:	Two (2) National 10-P-130 triplex single acting slush pumps with 4-1/2" and 6" liners powered independently by EMD 16-567 diesel engines.
ENGINE GENERATOR UNITS:	Two (2) 750 kw 480 volt AC generators, each driven by EMD 12-567 diesel engines.
ROTARY:	National C-375, 37.5" minimum bore driven by drawworks power.
CROWN:	National, 500 ton capacity.
TRAVELING HOOK/BLOCK:	National 650G-500 rated at 500 tons with block guidance system.
SWIVEL:	National P-500 ton capacity.
KELLY:	Two (2) 5-1/4" hex
KELLY SPINNER:	Varco 6600
ROTARY HOSE:	Two 3" x 65', 5,000 psi wp
SPINNING WRENCH:	Varco SSW-10
DRILL LINE:	1-3/8"
WIRELINE UNIT:	Halliburton .092"
FISHING TOOLS:	As required for Contractor's drill string
INSTRUMENTATION:	Weight indicator Mud pressure gauge Torque indicator Flowmeter Tong Torque indicator Pit volume totalizer with gain/loss alarm Geograph 6-pen recorder Deviation surveying equipment 0° - 16° Petron Flo/Show System with depth/ROP, pump strokes, calculating gpm, flow line sensor, pit volume, toolpusher's alarmable remote with silent printer, drill mode, trip mode and gas detector. Petron computerized ambient gas detector

BEST AVAILABLE COPY

SHALE SHAKER:	Brandt dual shale shakers cascading into Dual Derrick Flo-Line Cleaners.
DESANDER:	Two 12" cone Demco desander
DESILTER:	Swaco Mud Cleaner
DEGASSER:	Swaco degasser
CENTRIFUGAL PUMPS:	Six 6x8 100 psi pumps, 75 hp
AIR COMPRESSOR:	Two Atlas Copco BT-5
QUARTERS:	48-man quarters complete with galley, mess, recreation rooms, laundry, offices, and hospital
HELIPORT:	60'x60' diameter design for Sikorsky S-61
COMMUNICATION SYSTEM:	RF communication "single side band" radio; VHF marine telephone; ship-to-shore radio, inter-rig communication system
CRANES:	One (1) Marathon Letourneau PCM-120 with 100' boom rated at 98,400 lbs at a 24' radius; one (1) Link-Belt ABS 108-B with 70' boom rated at 64,100 lbs. at 15' radius
LIFE SAVING & FIRE PROTECTION:	Two 28-man Whittaker survival capsules All USCG required life and work vests, ring buoys, smoke and lighted signals
WEATHER INSTRUMENTS:	Wind speed and direction unit
BOP EQUIPMENT:	One 21-1/4" Shaffer 2000 psi wp annular preventer One Shaffer 13-5/8" annular preventer, 5,000 psi wp One Cameron "U" single, 10,000 psi wp; one Cameron "U" double, 10,000 psi wp One choke manifold, 10,000 psi wp, Kooimey BOP Control Unit

BEST AVAILABLE COPY

MARINE 225

QUARTERS ARRANGEMENT

→ FWD.

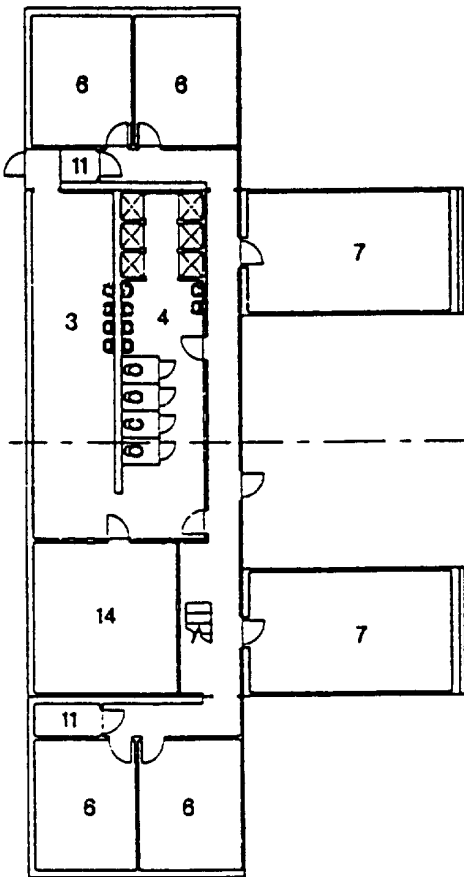

CAPACITY: (32) MEN
LOWER LEVEL

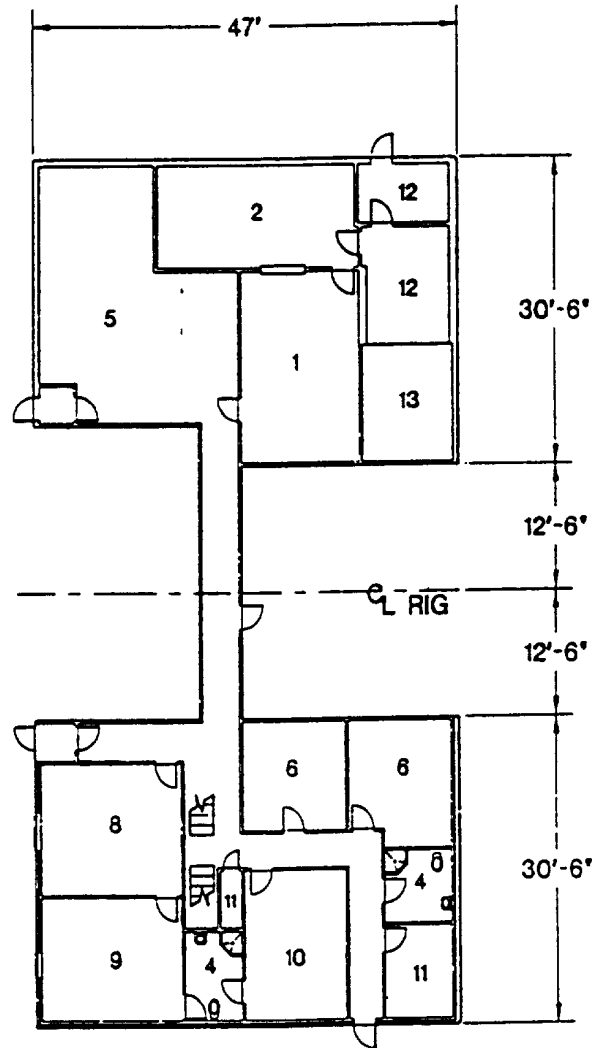

CAPACITY: (16) MEN
MAIN DECK LEVEL

KEY

BEST AVAILABLE COPY

- | | |
|------------------------|-----------------------------|
| 1 MESS | 8 RIG OFFICE |
| 2 GALLEY | 9 TOOLPUSHER'S STATE ROOM |
| 3 LOCKER ROOM | 10 COMPANY MAN'S STATE ROOM |
| 4 WASH ROOM | 11 STORAGE |
| 5 RECREATION ROOM | 12 PANTRY |
| 6 FOUR MAN STATE ROOM | 13 FREEZER |
| 7 EIGHT MAN STATE ROOM | 14 EQUIPMENT ROOM |

MARINE 225

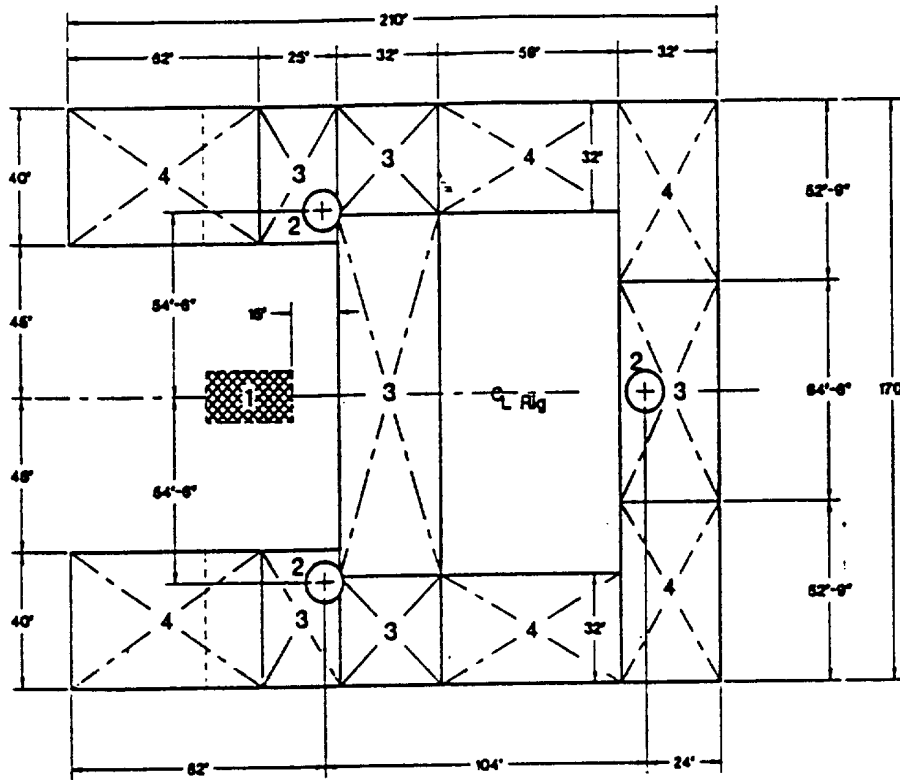

KEY

- 1 DRILLING WINDOW
27'-6" X 15'
- 2 12' DIA. LEG
- 3 PERMANENTLY BUOYANT TANK
- 4 PERMANENTLY FLOODED TANK

MAT PLAN

BEST AVAILABLE COPY

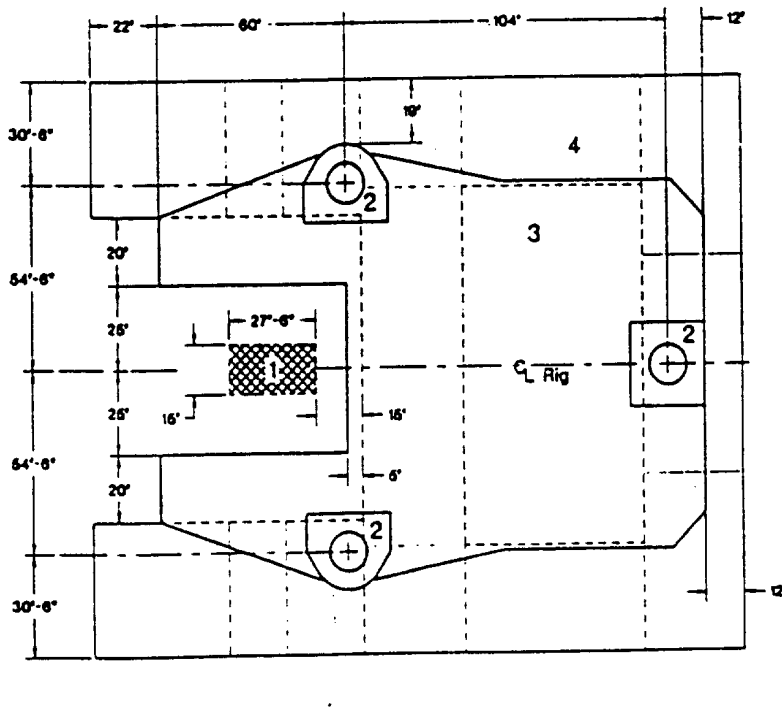

KEY

- 1 DRILLING WINDOW
27'-6" X 15'
- 2 12' DIA. LEG
- 3 BARGE HULL
- 4 MAT HULL

OVERVIEW OF PLATFORM AND MAT

MARINE 225

KEY

- 1 DRILLING WINDOW
27'-6" X 15'
- 2 JACK HOUSE
- 3 AC GENERATOR
- 4 MUD PIT
- 5 SWITCHBOARD
- 6 MUD PUMP
- 7 AUX. MACHINERY ROOM
- 8 SEWAGE TREATMENT UNIT
- 9 SACK STORAGE
- 10 LOWER DECK QUARTERS
- 11 STORES

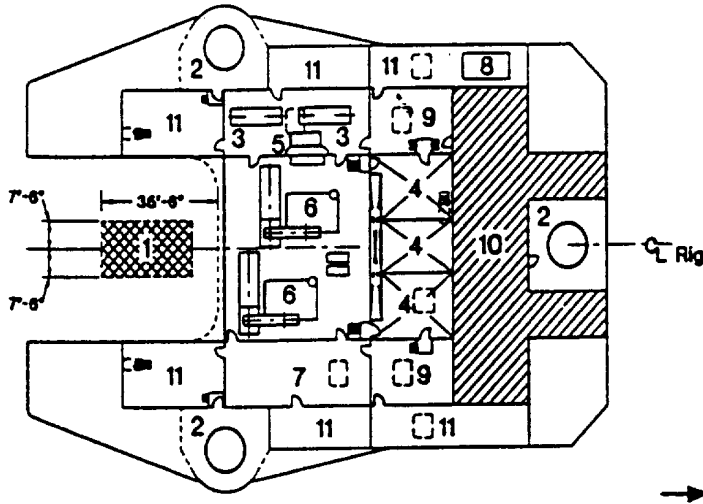

MACHINERY DECK

BEST AVAILABLE COPY

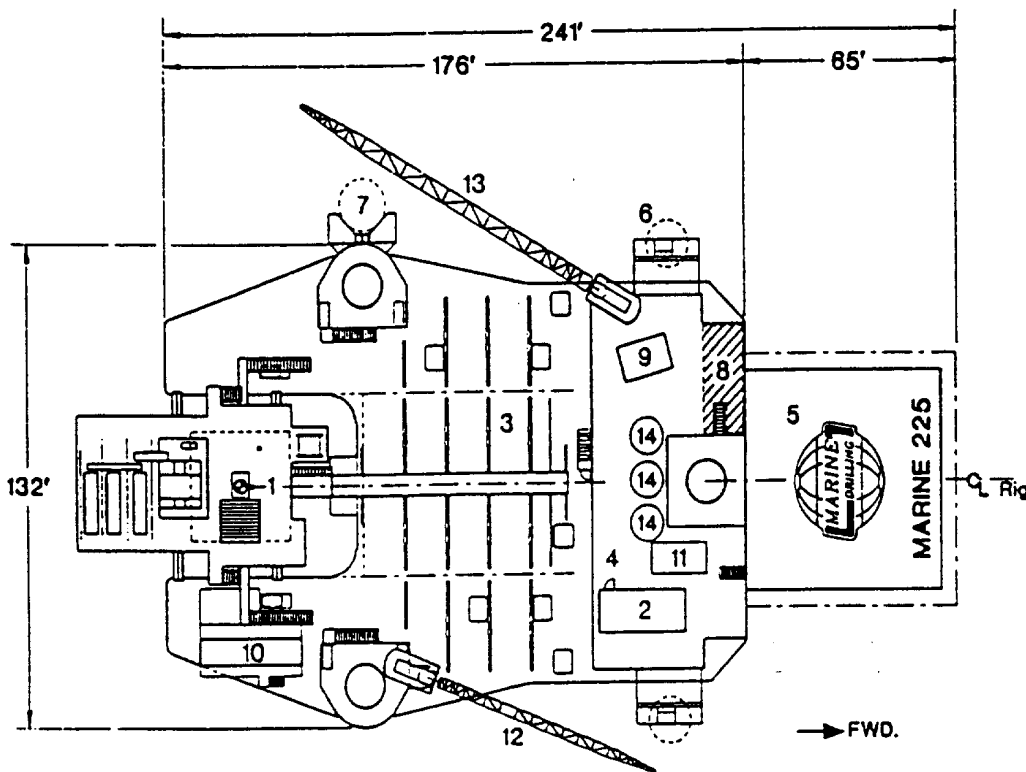

KEY

- 1 DRILL FLOOR
- 2 CONTROL HOUSE
- 3 PIPE RACK
- 4 QUARTERS HOUSE
- 5 HELIDECK (60' X 60')
- 6 LIFE CAPSULE
- 7 LIFE RAFT
- 8 SAFE WELDING AREA
- 9 LOGGING UNIT
- 10 SHALE SHAKER HOUSE
- 11 CEMENTING UNIT
- 12 LINK-BELT ABS 108B
CRANE W/ 70 FT. BOOM
- 13 PCM-120 AS
CRANE W/ 100 FT. BOOM
- 14 P-TANK

HELICOPTER DECK

MARINE 225

ALLOWABLE SKID UNIT LOADING

BEST AVAILABLE COPY

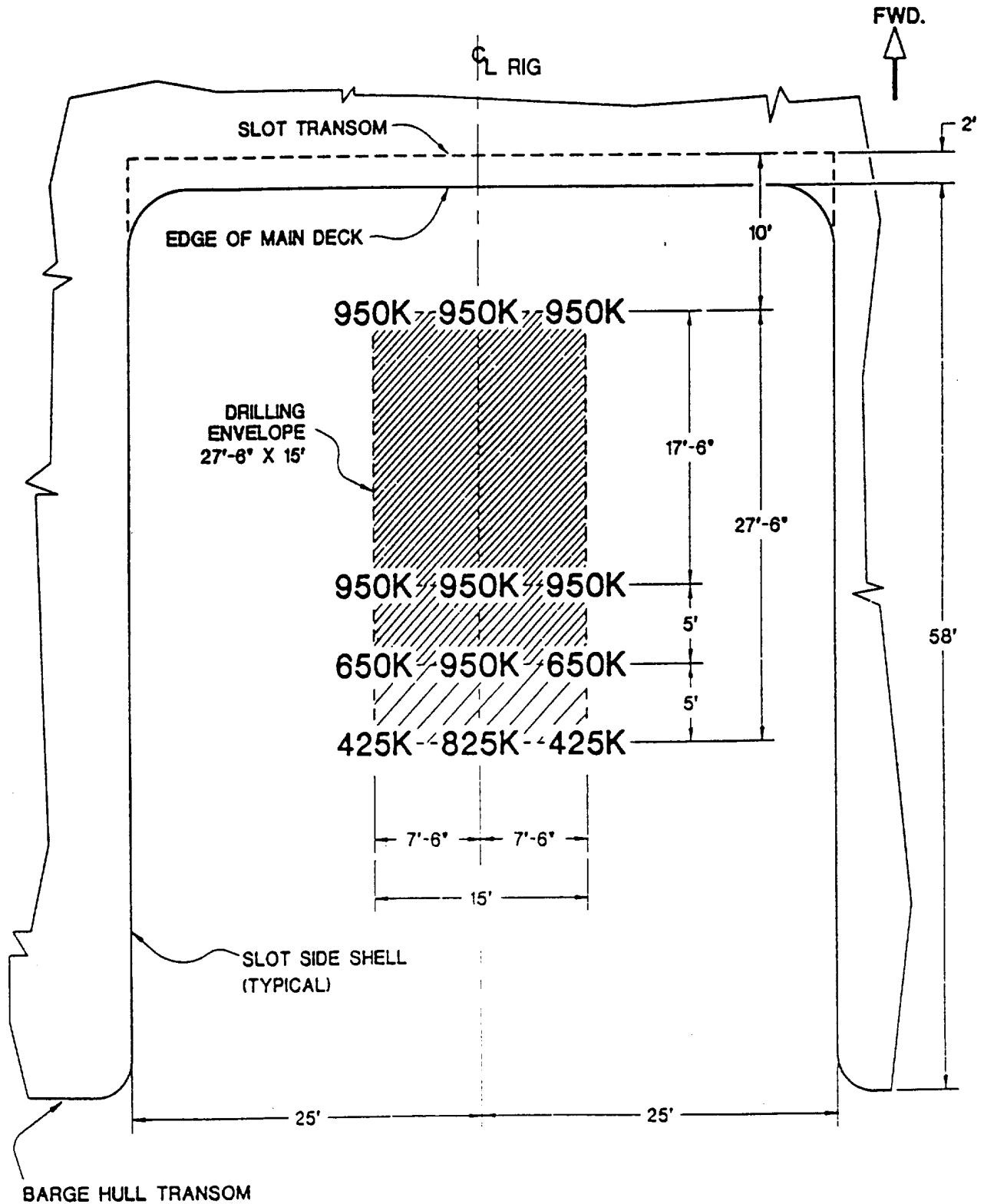

MARINE 225 OUTBOARD PROFILE

BEST AVAILABLE COPY

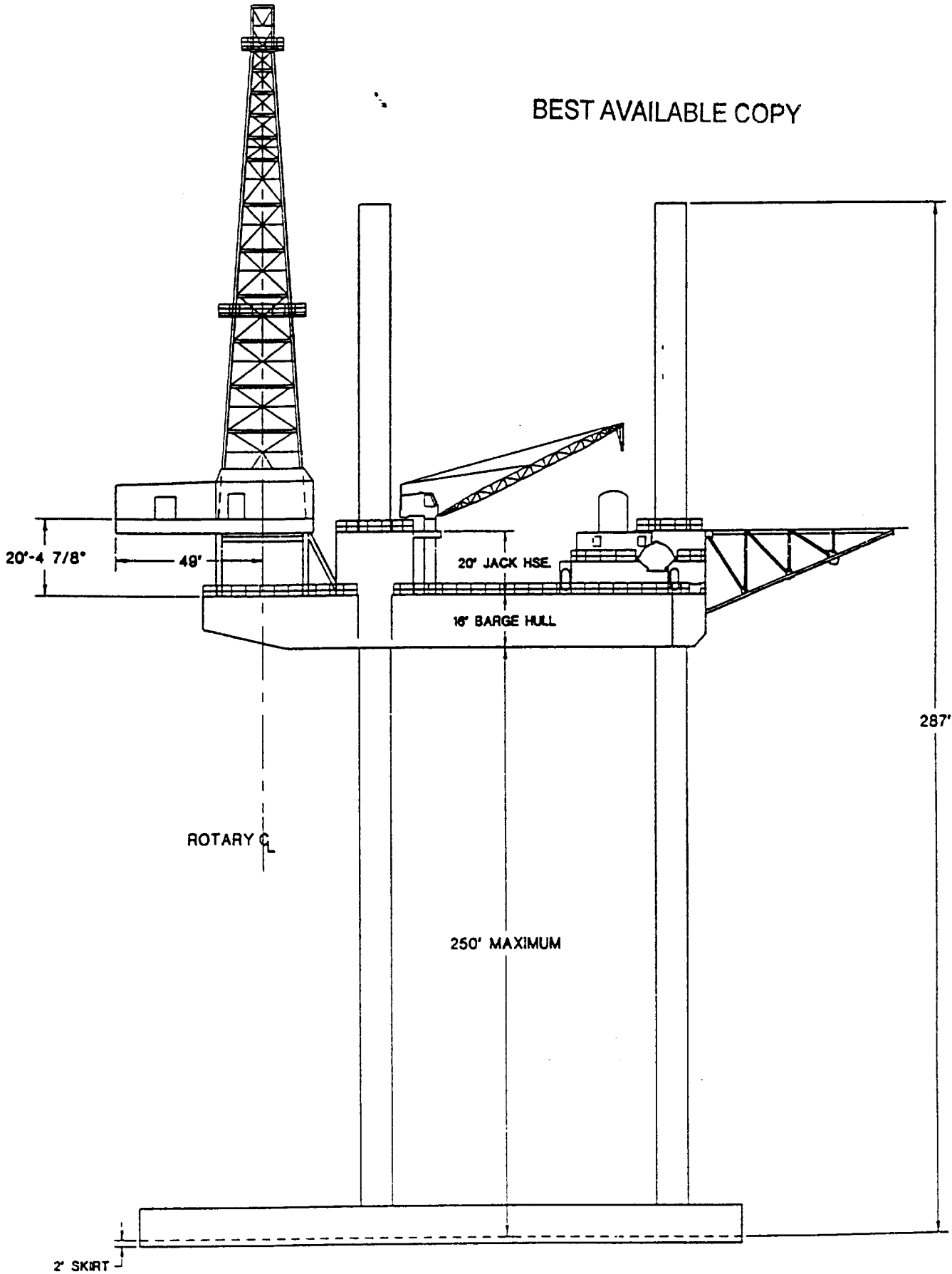

MARINE DRILLING COMPANIES

BEST AVAILABLE COPY

Bethlehem Hull 4846

Mobile Drilling Unit "MARINE 225"

OPERATING CAPABILITIES

The Mobile Drilling Unit is capable of operating in the Gulf of Mexico at a sinking depth, at mean low tide, of 225' in non-hurricane season. In this maximum water depth, the platform will have a vertical clearance above still water level of approximately 25'. During hurricane season, the sinking depth is to be limited to 175'.

The unit is designed to withstand 100 knot winds and 59-1/2" wave forces in 175' of water. Wind and wave forces are determined using ABS calculation procedures.

INTERNATIONAL LOAD LINE CERTIFICATE (1966)

Issued under the provisions of the International Convention on Load Lines, 1966, under the authority of the Government of the



UNITED STATES OF AMERICA,

Commandant, U. S. Coast Guard,

by the American Bureau of Shipping

duly authorized for assigning purposes under the provisions of the Convention

7000201-7

Certificate No.

Name of Ship	Official number or Distinctive Letters	Port of Registry	Length (L) as defined in Article 2 (8); i.e., 46 CFR 42.13-15
MARINE 225	523782	HOUSTON, TEXAS	168'-11-1/2"

Freeboard assigned as:

* { A new ship
* Existing ship

Type of Ship

XXXXXX
Type "A"
Type "B"
Type "B" with reduced freeboard
Type "B" with increased freeboard

* Delete whatever is inapplicable.

TO CENTER OF RING 8'-7-5/8"

Freeboard from deck line

Load Line

Tropical	N/A	feet	N/A	inches (T)	N/A	inches above (S)
Summer	N/A	feet	N/A	inches (S)	N/A	Upper edge of line through center of ring
Winter	N/A	feet	N/A	inches (W)	N/A	inches below (S)
Winter North Atlantic	N/A	feet	N/A	inches (WNA)	N/A	inches below (S)

Note: Freeboards and load lines which are not applicable need not be entered on the certificate.

Allowance for fresh water for all freeboards N/A inches.

Note: All measurements are to upper edge of the respective horizontal lines.

The upper edge of the deck line from which these freeboards are measured is OPPOSITE TOP OF STEEL UPPER deck at side.

THIS CERTIFICATE IS VALID ONLY SO LONG AS THE OPERATING RESTRICTIONS IN THE UNIT'S CAPABILITY LETTER ISSUED BY THE COAST GUARD MARINE SAFETY CENTER AND DATED 4 MARCH 1988 ARE OBSERVED.



BEST AVAILABLE COPY

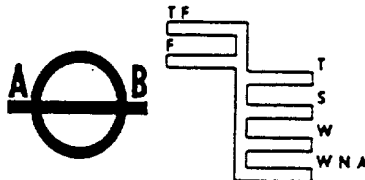

Date of initial or periodical survey

30 SEPTEMBER 1993

THIS IS TO CERTIFY that this ship has been surveyed and that the freeboards have been assigned and load lines shown above have been marked in accordance with the International Convention on Load Lines, 1966.

This Certificate is valid until 30 SEPTEMBER 1998

** subject to annual surveys

in accordance with Article 14 (1) (c) of the Convention, and endorsement thereof on the reverse side of the Certificate.

**At the expiration of this certificate, applicable reissuance should be obtained in accordance with the Load Line Regulations.

Issued at HOUSTON, TEXAS 30 JANUARY 1995

The undersigned declares that he is duly authorized by the said Government to issue this Certificate.

[Handwritten Signature]

SURVEY MANAGER, ABS AMERICAN BUREAU OF SHIPPING



Department of Transportation

United States Coast Guard
National Pollution Funds Center
Arlington, VA 22203-1804



CERTIFICATE OF FINANCIAL RESPONSIBILITY (WATER POLLUTION)

KNOW ALL PERSONS BY THESE PRESENTS THAT
Vessel Operator
MARINE DRILLING MANAGEMENT CO.

No. 837119-02

has established financial responsibility to meet liability under section 311(p) of the Federal Water Pollution Control Act, as amended, which may result from operation of the vessel named below:

BEST AVAILABLE COPY

Name of Vessel

MARINE 225

Expires JUN 7, 1997

The use of this certificate is subject to the provisions of Part 130 of Title 33 of the Code of Federal Regulations, as it is or may be amended, and the conditions on the reverse side of this certificate. This certificate is void if there are any erasures or alterations hereon, and is void if the operator named hereon is not the party responsible for operating the vessel.

Richard A. Castellano

Chief, Vessel Certification Division
National Pollution Funds Center
By Direction of the Commander

MARINE DRILLING COMPANIES

BOP OPERATING PROCEDURE

During drilling operations the 13-5/8" annular preventer and both ram type and blind rams are in the open position. The hydraulically operated 4" valve is in the closed position and all manual inside valves are open. If a kick or blowout occurs, you may elect to close either the annular or ram type BOP. At this time, the hydraulically opened 4" valve should be placed in the open position to route the fluid or gas to the choke manifold. With the choke manifold valve closed, well bore pressure can be read and recorded.

MARINE 225

BOP SYSTEM

BEST AVAILABLE COPY

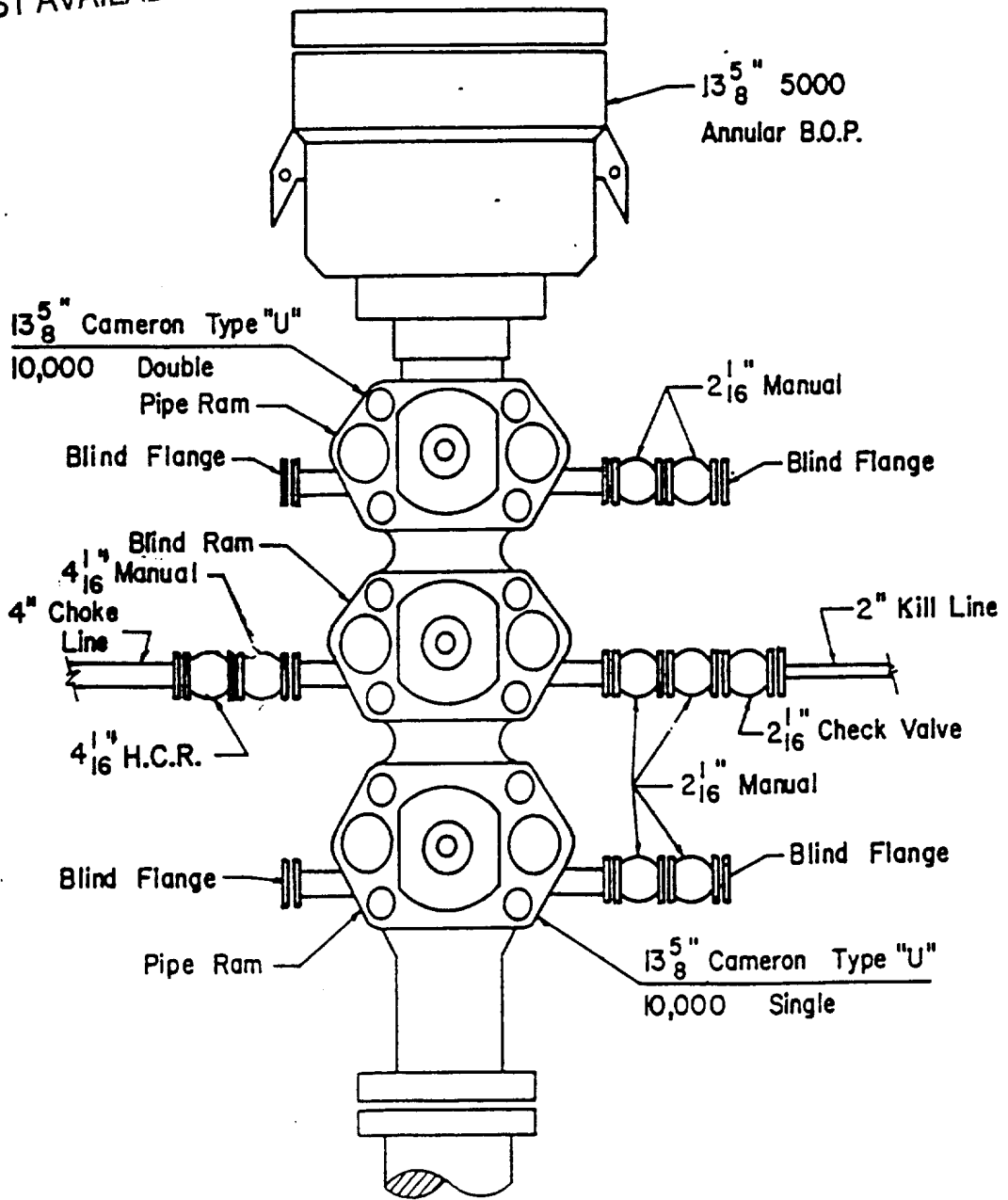

MARINE DRILLING COMPANY

DIVERTER SYSTEM OPERATION PROCEDURE

During drilling operations, the 21-1/4" annular preventer is in the open position with the hydraulic valves being closed. If a kick or blowout occurs, the 21-1/4" annular preventer is closed and both hydraulic valves opened. Subsequently, both valves may be left open or either valve closed at the Operator's discretion.

MARINE 225

DIVERTER SYSTEM

PLAN VIEW

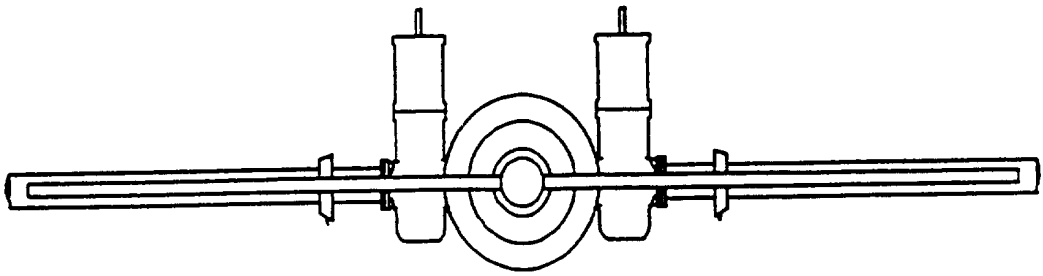

BEST AVAILABLE COPY

ELEVATION VIEW

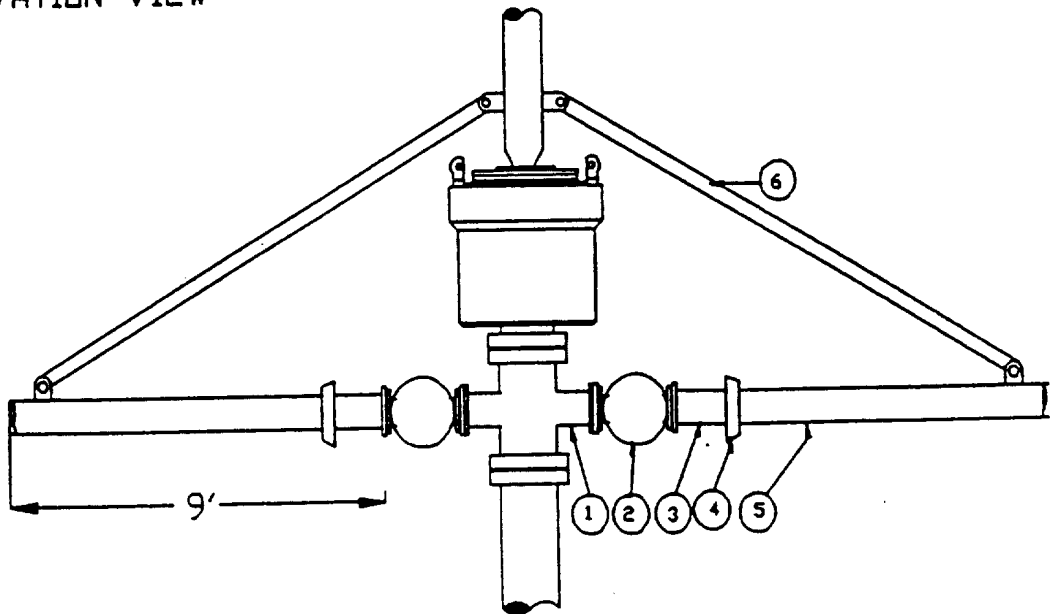

1. 21-1/4" diverter spool with 10" outlets rated at 2000 psi
2. 10" Demco type "B" Ball valve series 600, 1480 psi
3. 10" extra strength nipple 3130 wp
4. 10" Harrisburg Union Fig. 206, 2000 psi
5. 10-3/4" OD casing; .279 wall drift to 10.036 ID, 3130 wp
6. 2" schedule 80 pipe

EMISSIONS INFORMATION

MARINE 225

<u>Qty</u>	<u>Engine</u>	<u>Horsepower</u>	
2	D-399 Caterpillar	1250 hp ea x 2 =	2,500 hp
2	567-12 EMD Gen	1200 hp ea x 2 =	2,400 hp
2	567-16 EMD Pump	1600 hp ea x 2 =	3,200 hp
1	3306 Caterpillar Emergency Gen	200 hp ea x 1 =	200 hp
1	471 Detroit crane engine	120 hp ea x 1 =	<u>120 hp</u>
	TOTAL HP		<u>8,420 hp</u>

BEST AVAILABLE COPY

ATTACHMENT C

CONDITIONS OF APPROVAL
FOR DESIGNATED SAFE WELDING AND BURNING AREAS

1. If a diesel intake point is located within 35 feet of the designated safe welding and burning area, the following must be adhered to:
 - a.. Welding and burning operations will not be performed while diesel loading or off loading operations are being performed due to the close proximity of the fuel line.
 - b. A sign will be posted at the diesel intake point, indicating welding and burning will be shut down in the safe welding and burning area during diesel loading and off loading operations.
2. If a mud room hatch is located within 35 feet of the designated safe welding area, the hatch must be closed when welding and burning operations are being performed.
3. The designated safe welding and burning area will be clearly marked and identified.

BEST AVAILABLE COPY

MARINE DRILLING COMPANIES

EVACUATION AND COMMUNICATION EQUIPMENT

Evacuation Equipment:

Standby Boat (if available)
Two 50-man Whittaker capsules - range 135 miles
Eight right buoys
One personnel basket - normal 4-man capacity
Two emergency escape ladders

Communication Equipment:

VHF-FM marine band radio - all marine channels 156-158 MHz
Single Sideband Marine Radio 4, 8, and 12 MHz marine operator
4125.0 MHz
8297.0 MHz
4610.5 MHz (MDC frequency)
13098.0 MHz
Rig Public Address Systems

BEST AVAILABLE COPY



MARINE DRILLING COMPANY STATION BILL

MAN OVERBOARD

Hail, pass the word "MAN OVERBOARD"
throw ring buoys over, alert standby boat,
prepare lifeboat for launching, send lookout aloft.

FIRE SIGNAL

Rapid succession of short soundings of the
general alarm bells of not less than 10 seconds

DISMISSAL FROM DRILLS

Three short rings of general alarm

ABANDON RIG SIGNAL

A continuous ringing of the general alarm bells

FIRE AND EMERGENCY

ABANDON RIG

PERSONNEL	STATUS	STATION	DUTIES	STATION	DUTIES
1. Toolpusher	On Duty	Scene of Fire	In Charge of All Personnel	No. 1 Capsule	In Charge
2. Driller	On Duty	Drill Floor	Responsible Driller/Standby on Drill Floor for Operator Instructions.	No. 1 Capsule	As Directed by Person in Charge.
3. Derrickman	On Duty	Toolpushers Office	Standby	No. 1 Capsule	As Directed by Person in Charge.
4. Floorman	On Duty	Toolpushers Office	Standby in Toolpushers Office	No. 1 Capsule	As Directed by Person in Charge.
5. Floorman	On Duty	Toolpushers Office	Standby in Toolpushers Office	No. 1 Capsule	As Directed by Person in Charge.
6. Floorman	On Duty	Toolpushers Office	Standby in Toolpushers Office	No. 1 Capsule	As Directed by Person in Charge.
7. Mechanic	On Duty	Scene of Fire	Standby for Assistance to Toolpushers Office.	No. 1 Capsule	Commander of Capsule—Alert to Kill.
8. Crane Operator	On Duty	Toolpushers Office	Standby for Assistance to Toolpushers Office.	No. 1 Capsule	As Directed by Person in Charge.
9. Roustabouts	On Duty	Day Room	Standby in Day Room	No. 1 Capsule	As Directed by Person in Charge.
10. Roustabouts	On Duty	Day Room	Standby in Day Room	No. 1 Capsule	As Directed by Person in Charge.
11. Roustabouts	On Duty	Day Room	Standby in Day Room	No. 1 Capsule	As Directed by Person in Charge.
12. Roustabouts	On Duty	Day Room	Standby in Day Room	No. 1 Capsule	As Directed by Person in Charge.
13. Welder	On Duty	Day Room	Standby in Day Room	No. 1 Capsule	As Directed by Person in Charge.
14. Galley Crew	On Duty	Living Quarters/Galley	Standby in Day Room	No. 1 Capsule	As Directed by Person in Charge.
15. Galley Crew	On Duty	Living Quarters/Galley	Standby in Day Room	No. 1 Capsule	As Directed by Person in Charge.
16. Company Man/Op.	On Duty	Radio Room	Standby in Day Room	No. 2 Capsule	Call U.S. Coast Guard and report to Capsule.
17. Driller	Off Duty	Toolpushers Office	Standby in Day Room	No. 2 Capsule	Commander of Capsule—Alert to Kill.
18. Derrickman	Off Duty	Day Room	Standby in Day Room	No. 2 Capsule	As Directed by Person in Charge.
19. Floorman	Off Duty	Day Room	Standby in Day Room	No. 2 Capsule	As Directed by Person in Charge.
20. Floorman	Off Duty	Day Room	Standby in Day Room	No. 2 Capsule	As Directed by Person in Charge.
21. Floorman	Off Duty	Day Room	Standby in Day Room	No. 2 Capsule	As Directed by Person in Charge.
22. Mechanic	Off Duty	Scene of Fire	Standby in Day Room	No. 2 Capsule	As Directed by Person in Charge.
23. Galley Crew	Off Duty	Day Room	Standby in Day Room	No. 2 Capsule	As Directed by Person in Charge.
24. Galley Crew	Off Duty	Day Room	Standby in Day Room	No. 2 Capsule	As Directed by Person in Charge.
25. Service Personnel	Off Duty	Day Room	Standby in Day Room	No. 2 Capsule	As Directed by Person in Charge.
26. Service Personnel	Off Duty	Day Room	Standby in Day Room	No. 2 Capsule	As Directed by Person in Charge.
27. Service Personnel	Off Duty	Day Room	Standby in Day Room	No. 2 Capsule	As Directed by Person in Charge.
28. Service Personnel	Off Duty	Day Room	Standby in Day Room	No. 2 Capsule	As Directed by Person in Charge.
29. Service Personnel	Off Duty	Day Room	Standby in Day Room	No. 2 Capsule	As Directed by Person in Charge.
30. Service Personnel	Off Duty	Day Room	Standby in Day Room	No. 2 Capsule	As Directed by Person in Charge.
31. Service Personnel	Off Duty	Day Room	Standby in Day Room	No. 2 Capsule	As Directed by Person in Charge.
32. Service Personnel	Off Duty	Day Room	Standby in Day Room	No. 2 Capsule	As Directed by Person in Charge.
33. Service Personnel	Off Duty	Day Room	Standby in Day Room	No. 2 Capsule	As Directed by Person in Charge.
34. Service Personnel	Off Duty	Day Room	Standby in Day Room	No. 2 Capsule	As Directed by Person in Charge.
35. Service Personnel	Off Duty	Day Room	Standby in Day Room	No. 2 Capsule	As Directed by Person in Charge.
36. Service Personnel	Off Duty	Day Room	Standby in Day Room	No. 2 Capsule	As Directed by Person in Charge.
37. Service Personnel	Off Duty	Day Room	Standby in Day Room	No. 2 Capsule	As Directed by Person in Charge.
38. Service Personnel	Off Duty	Day Room	Standby in Day Room	No. 2 Capsule	As Directed by Person in Charge.
39. Service Personnel	Off Duty	Day Room	Standby in Day Room	No. 2 Capsule	As Directed by Person in Charge.
40. Service Personnel	Off Duty	Day Room	Standby in Day Room	No. 2 Capsule	As Directed by Person in Charge.
41. Visitor	Off Duty	Day Room	Standby in Day Room	No. 2 Capsule	As Directed by Person in Charge.
42. Visitor	Off Duty	Day Room	Standby in Day Room	No. 2 Capsule	As Directed by Person in Charge.
43. Visitor	Off Duty	Day Room	Standby in Day Room	No. 2 Capsule	As Directed by Person in Charge.
44. Visitor	Off Duty	Day Room	Standby in Day Room	No. 2 Capsule	As Directed by Person in Charge.
45. Visitor	Off Duty	Day Room	Standby in Day Room	No. 2 Capsule	As Directed by Person in Charge.
46. Visitor	Off Duty	Day Room	Standby in Day Room	No. 2 Capsule	As Directed by Person in Charge.
47. Visitor	Off Duty	Day Room	Standby in Day Room	No. 2 Capsule	As Directed by Person in Charge.
48. Visitor	Off Duty	Day Room	Standby in Day Room	No. 2 Capsule	As Directed by Person in Charge.

- All persons shall familiarize themselves with the locations and duties of their emergency stations upon reporting aboard.
- All persons will be required to wear a life preserver when reporting to emergency stations.
- Toolpusher shall insure that temporary personnel are instructed in these emergency procedures.
- Toolpusher to provide specific instructions as necessary to implement the provisions of this bill.
- Toolpusher to keep this bill up to date and modify the provisions as necessary when circumstances dictate.
- When abandoning a rig due to a leak, the rig is to be abandoned in accordance with Operators posted instructions.
- During an abandon situation:
 - Close all Water-tight doors.
 - Secure all engines.
 - Send out distress radio traffic as directed by person in charge.
 - Lifeboat and capsule will not be lowered until the Order to Abandon is given by the person in charge.

BEST AVAILABLE COPY

AREA DIAGRAM Of Appointed Stations

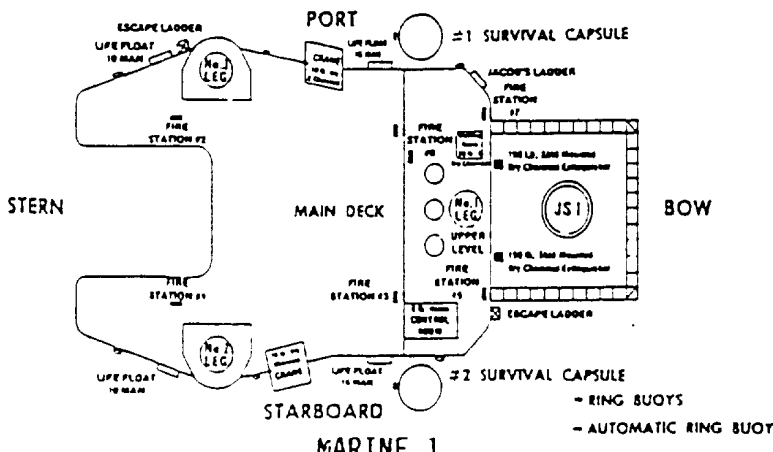

For Those Rigs That Have Fixed Fire Extinguishing Systems - Activate System On Command.

In the Event of ABANDON SHIP. When Lifeboat/Liferaft Assignments Can Not Be Carried Out in Accordance With The Directions in This Station Bill, Toolpusher Will Make Reassignments.

DIAGRAM On Use and Wearing of Life Preserver

TYPE I PERSONAL FLOTATION DEVICE (KAPOK)

- LIFE PRESERVERS ARE TO BE TIED OFF AT THE NECK AND WAIST SECURELY.
- THE CHEST STRAP BUCKLE IS TO BE CLIPPED OR SNAPPED SHUT, AND STRAP SHOULD BE CINCHED UP SECURELY.
- WHEN THIS LIFE PRESERVER IS WORN CORRECTLY, IT WILL TURN AN UNCONSCIOUS WEARER FROM A FACE-DOWN POSITION ONTO HIS BACK AND INTO A FACE-UP POSITION IN A MATTER OF ABOUT TWO SECONDS.

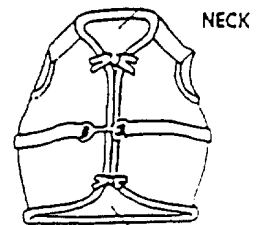

Master or Person in Charge

Maintenance or repairs which are necessary to prevent pollution of offshore waters shall be undertaken immediately.

There shall be no disposal of equipment, cables, containers, or other materials into offshore waters.

STRUCTURE MAP

A current structure map drawn to the top of each prospective hydrocarbon accumulation showing the surface and bottom hole location of the subject well is included as Attachment C.

OEDC proposes to develop the shallow Miocene Sand reservoir as seen in the existing wells. Based on well tests, OEDC anticipates produced hydrocarbons to consist of dry, sweet gas with little or no condensate.

BEST AVAILABLE COPY

BATHYMETRY MAP

Well No. 1 in Destin Dome Blocks 1 and 2 are located approximately 20 miles from the nearest shoreline in approximately 105 feet of water. A bathymetry map showing the surface location of the subject well is included as Attachment D.

CROSS SECTION

A generalized stratigraphic column from the surface to total depth and deep seismic lines intersecting at or near the primary well location are necessary to evaluate geologic conditions.

A cross section map with deep seismic lines depicting the subject well location and the geologic name and age of the anticipated structure is included as Attachments E-1 and E-2.

SHALLOW HAZARDS

Shallow hazards analyses for the existing surface locations of the subject wells in Destin Dome Blocks 1 and 2 evaluating any seafloor and subsurface geologic and manmade features and conditions were included with previously approved Plans of Exploration.

OIL SPILL CONTINGENCY PLAN

All production operations shall be performed in accordance with industry standards to prevent pollution of the environment. OEDC Exploration & Production, L.P.'s Oil Spill Contingency Plan is being reviewed by MMS. This plan designates an Oil Spill Response Team consisting of OEDC personnel and contract personnel. This team's duties are to eliminate the source of any spill, remove all sources of possible ignition, deploy the most reliable means of available transportation to monitor the movement of a slick, and contain and remove the slick if possible.

OEDC's Oil Spill Response Team attends drills for familiarization with pollution-control equipment and operations procedures on an annual basis.

OEDC is a member of Clean Gulf Associates (CGA). The CGA stores pollution control equipment at two locations in Texas, at Port Aransas and Galveston; five locations in Louisiana, at Venice, Grand Isle, Intracoastal City, Houma and Cameron and one location in Alabama, at Theodore.

Each base is equipped with fast response skimmers and there is a barge mounted high volume open sea skimmer based at Grand Isle, Louisiana. In addition to providing equipment, the CGA also supplies advisors for clean-up operations. Equipment available from CGA and the base it is located at is listed in the CGA Manual, Volume I, Section III.

OEDC will make every effort to see that a spill is responded to as quickly as possible. Response equipment and response times will be suitable for anticipated environmental conditions in the area.

In good weather conditions fast response with oil boom, skimmers, pump and storage tanks would require approximately 10 to 11 hours, including preparation time as indicated below. A heavy equipment system response would require approximately 24-36 hours, including 6 hours preparation time.

	<i>BEST AVAILABLE COPY</i>	<i>HOURS</i>
1. Procurement of vessel capable of transporting oil spill containment equipment and deployment to the nearest CGA base in Theodore, Alabama		3.0
2. Load out Fast Response Unit		2.0
3. Travel Time to Lease Site		4.5
4. Deployment of Equipment at Spill Site		<u>1.0</u>
Estimated Total Time		10.5

BEST AVAILABLE COPY

Equipment located in Theodore, Alabama would be utilized first with additional equipment transported from the nearest equipment base as required.

In the event a spill occurs from the surface location in Destin Dome Blocks 1 and 2, our company has projected trajectory of a spill impacting the coastline, utilizing information in the Minerals Management Service's Oil Spill Risk Analysis for the Central and Western Gulf of Mexico OCS Lease Sales 157 and 161.

The report contains oil spill trajectory simulations using seasonal surface currents coupled with wind data, adjusted every 3 hours for 30 days or until a target is contacted. Hypothetical spill trajectories were simulated for each of the potential launch sites across the entire Gulf. These simulations presume 500 spills occurring in each of the four seasons of the year. The results in the report were presented as probabilities that an oil spill beginning from a particular launch site would contact a certain land segment within 3, 10, or 30 days.

Utilizing the summary of the trajectory analysis (for 10 days) as presented in the MMS' report, the probability of an oil spill from Destin Dome Blocks 1 and 2 is as follows:

<i>AREA/BLOCK</i>	<i>LAND SEGMENT</i>	<i>%</i>	<i>CGA MAP NO.</i>
Destin Dome Blocks 1 and 2	Plaquemines, LA	1%	Maps No. 6 & 7
	St. Bernard, LA etal	1%	Maps No. 7 & 8
	Hancock, MS etal	2%	Map No. 9
	Mobile, AL	2%	Map No. 9
	Baldwin, AL	10%	Maps No. 9 & 10
	Escambia County, FL etal	9%	Map No. 10
	Okaloosa County, FL	1%	Maps No. 10 & 11

If a spill should occur from the subject location, OEDC would immediately activate its Emergency Response Team, determine from current conditions the probable location and time of land fall by contacting SpillNet. Then, using the Clean Gulf Operations Manual, Volume II, identify any biologically sensitive areas and determine the appropriate response mode.

In June, 1996, OEDC contracted SpillNet, Inc. to provide environmental sensitive areas of the shorelines that may be affected by the proposed operations. Environmental Sensitivities Maps 1 through 8 are included as Attachment F.

Section VI, Volume II of the CGA Operations Manual depicts the protection response modes that are applicable for oil spill clean-up operations. Each response mode is schematically represented to show optimum deployment and operation of the equipment in areas of environmental concern.

Implementation of the suggested procedures assures the most effective use of the equipment and will result in reduced adverse impact of oil spills on the environment. Supervisory personnel have the option to modify the deployment and operation of equipment to more effectively respond to site-specific circumstances.

NEW OR UNUSUAL TECHNOLOGY

No new techniques or unusual technology will be required for these operations.

LEASE STIPULATIONS

Oil and gas exploration/development activities on the OCS are subject to stipulations developed before the lease sale and would be attached to the lease instrument, as necessary, in the form of mitigating measures. The MMS is responsible for ensuring full compliance with stipulations.

Lease Stipulation No. 1 attached to the subject lease instrument requires preparation of a Cultural Resources Report assessing the potential existence of any cultural resources.

As stated in Minerals Management Service Letter to Lessees (LTL) dated September 5, 1995, effective November 21, 1994, a final rule was published in the Federal Register which added a new section, 30 CFR 250.26, titled "Archaeological Reports and Surveys", to Minerals Management Service Operating Regulations. This rule was developed to convert the requirements contained in Stipulation No. 1 into regulations which apply to all leases located within areas determined as having a high probability for the occurrence of archaeological resources.

Lease Stipulation No. 4 requires control of electromagnetic emissions emanating from individual designated defense warning areas in accordance with requirements specified by the commander of the command headquarters to the degree necessary to prevent damage to, or unacceptable interference with, Department of Defense flight, testing or operations activities conducted within the warning area.

OEDC will enter into an agreement with the commander of the Eglin Air Force Base located in Florida for positive control of boats and aircraft operating within Military Area (W-155A) during proposed development operations.

BEST AVAILABLE COPY

CULTURAL RESOURCES

By Letter to Lessees (LTL) dated September 5, 1995, Minerals Management Service designated Destin Dome Blocks 1 and 2 as an area having a high probability for prehistoric archeological resources on the OCS. Therefore, an archeological resources report is required based on data from prehistoric site remote-sensing surveys.

Archaeological Assessments were included in the Geophysical Site Survey Reports prepared by KC Offshore, L.L.C. in July, 1996. Copies of the Geophysical Site Survey Reports were submitted under separate cover.

DISCHARGES

All discharges associated with the proposed activities will be in accordance with regulations implemented by Minerals Management Service (MMS), U. S. Environmental Protection Agency (EPA), and the U. S. Coast Guard (USCG).

The MMS issued a special advisory notice (NTL 86-11) strongly encouraging the oil and gas industry to take special educational, operational and awareness measures to reduce or eliminate contributions to marine debris in the Gulf of Mexico.

Annex V of the International Convention for the Prevention of Pollution from ships, also known as MARPOL Protocol, prohibits the dumping of all plastic wastes, including plastic packaging materials and fishing gear.

Destin Dome Blocks 1 and 2 are located in EPA Region IV. The NPDES General Permit GMG 280000 was only extended for those operators who had requested coverage prior to the expiration date of the permit. By letter dated August 3, 1995, Apache Corporation transferred permit responsibility, coverage and liability to OEDC. Therefore, the operations in Destin Dome Blocks 1 and 2 are covered under the existing NPDES General Permit GMG 280000.

Discharges will contain no free oil and will be in compliance with and monitored as required by the permit. Any drilling fluid contaminated with oil will be transported to shore for proper disposal at an authorized disposal site.

Solid domestic wastes will be transported to shore for proper disposal at an authorized disposal site, and sewage will be treated on location by U. S. Coast Guard approved marine sanitation devices.

HYDROGEN SULFIDE

BEST AVAILABLE COPY

By approval of the Plans of Exploration, Minerals Management Service classified the area in which the proposed operations are to be conducted as a zone where the absence of hydrogen sulfide has been confirmed.

PROJECTED EMISSIONS

Offshore air emissions related to the proposed activities result mainly from the drilling rig operations, helicopters and service vessels. These emissions occur mainly from combustion or

burning of fuels and natural gas and from venting or evaporation of hydrocarbons. The combustion of fuels occurs primarily on diesel-powered generators, pumps or motors and from lighter fuel motors. Other air emissions can result from catastrophic events such as oil spills or blowouts.

Primary air pollutants associated with OCS activities are nitrogen oxides, carbon monoxide, sulphur oxides, volatile organic compound, and suspended particulate.

OEDC will use a low sulphur fuel during these operations in the attempt to reduce the projected air pollutants.

Projected Air Quality Emissions which provide for the completion of the existing temporarily abandoned wells, installation of a lease term pipeline and commencement of production of Well No. 1 (Lease OCS-G 6397) and Well No. 1 (Lease OCS-G 6398) are included as Attachment G.

ENVIRONMENTAL REPORT

An Environmental Report is included as Attachment H.

BEST AVAILABLE COPY

COASTAL ZONE CONSISTENCY CERTIFICATION

Issues identified in the Coastal Zone Management Program include the following: general coastal use guidelines, levees, linear facilities (pipelines); dredged soil deposition; shoreline modifications, surface alterations, hydrologic and sediment transport modifications; waste disposal; uses that result in the alteration of waters draining into coastal waters; oil, gas or other mineral activities; and air and water quality.

Certificates of Coastal Zone Management Consistency for the State of Alabama and the State of Florida are enclosed as Attachment I-1 and I-2.

ONSHORE SUPPORT BASE

Well No. 1 in Destin Dome Blocks 1 and 2 are located approximately 20 miles from the nearest shoreline in water depths ranging from 102 to 107 feet. During completion operations, OEDC will utilize existing onshore facilities located in Theodore, Alabama. This will serve as a port of debarkation for supplies and crews. During production operations, McHugh's Dock in Dauphin Island, Alabama, will serve as the port of debarkation for supplies and crews. No onshore expansion or construction is anticipated with respect to the proposed operations.

A Vicinity Plat showing the location of Destin Dome Blocks 1 and 2 relative to the shoreline and onshore base is included as Attachment J.

The onshore support base is capable of providing the services necessary for the proposed activities. It has 24-hour service, a radio tower with a phone patch, dock space, equipment and supply storage base, drinking and drill water, etc. Support vessels and travel frequency during production activities are as follows:

	<i>COMPLETION</i>	<i>PRODUCTION</i>
Crew Boat	7 Trips Per Week	1 Trip Per Week
Supply Boat	7 Trips Per Week	1 Trip Per Week
Helicopter	1 Trip Per Week	0 Trips Per Week

AUTHORIZED REPRESENTATIVE

Inquiries may be made to the following authorized representative:

Cathy Thornton
 J. Connor Consulting, Inc.
 16225 Park Ten Place, Suite 500
 Houston, Texas 77084
 (713) 578-3388

BEST AVAILABLE COPY

LIST OF ATTACHMENTS

- A Well Location Table and Plat
- B Freestanding Caisson Schematic
- C Structure Map
- D Bathymetry Map
- E Cross Section and Seismic Maps
- F Environmental Sensitivities Maps 1 through 8
- G Projected Air Emissions
- H Environmental Report
- I Coastal Zone Consistency Certification
- J Vicinity Map

OEDC EXPLORATION & PRODUCTION, L. P.

**INITIAL JOINT DEVELOPMENT OPERATIONS
COORDINATION DOCUMENT**

DESTIN DOME BLOCKS 1 AND 2

LEASES OCS-G 6397/6398

WELL LOCATION TABLE

<u>WELL</u>	<u>LOCATION</u>	<u>TOTAL DEPTH</u>	<u>WATER DEPTH</u>	<u># OF DAYS</u>
<i>Destin Dome Block 1</i>				
1	SL: 5262' FSL & 5353' FEL			0/15
<i>Destin Dome Block 2</i>				
1	SL: 5318' FSL & 206' FWL			0/15

BEST AVAILABLE COPY

DESTIN DOME BLOCK 1
OCS-G-6397
(5760 ACRES)

DESTIN DOME BLOCK 2
OCS-G-6398
(5760 ACRES)

#1
OCS-G-6397
DESTIN DOME BLOCK 1
X = 1404,407.00
Y = 10,871,502.00

#1
OCS-G-6398
DESTIN DOME BLOCK 2
X = 1409,968.00
Y = 10,871,558.00

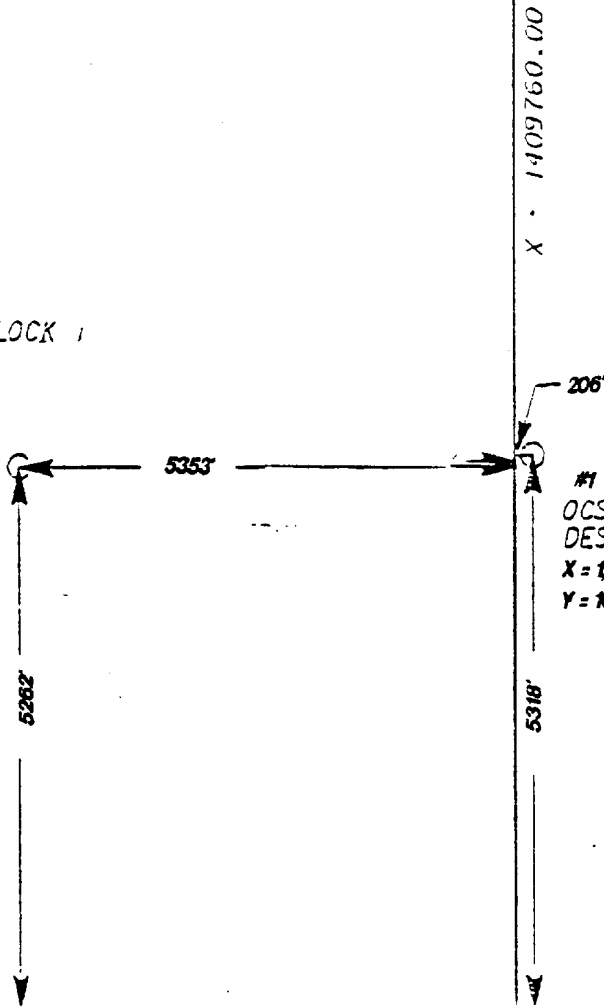

BEST AVAILABLE COPY

NOTE:
ALL COORDINATES ARE BASED ON UNIVERSAL TRANSVERSE
MERCATOR GRID COORDINATE SYSTEM, ZONE 16.

OEDC Exploration & Production, LP.

**Initial Joint Development
Operations Coordination Document**
LOCATION PLAT

DESTIN DOME BLOCKS 1 & 2
OCS-G-6397 & OCS-G-6398

APPROX 53 MILES SOUTHEAST OF MOBILE, ALA.

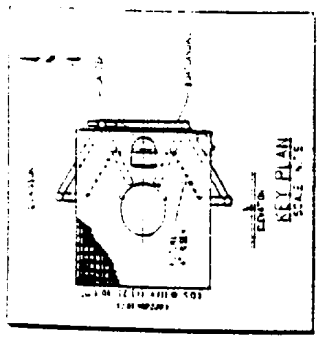

COMPONENT HEIGHTS	
ITEM	WEIGHT (LBS)
MAN JACK SUPPORTING FRAME	4
27\"/>	

GULF OF MEXICO

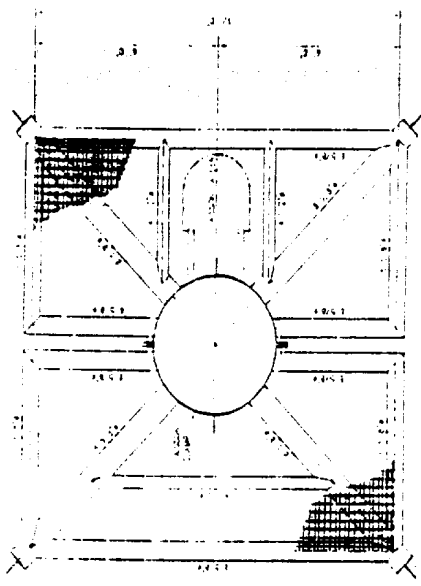

SPICE BECK FRAMING PLAN

BEST AVAILABLE COPY

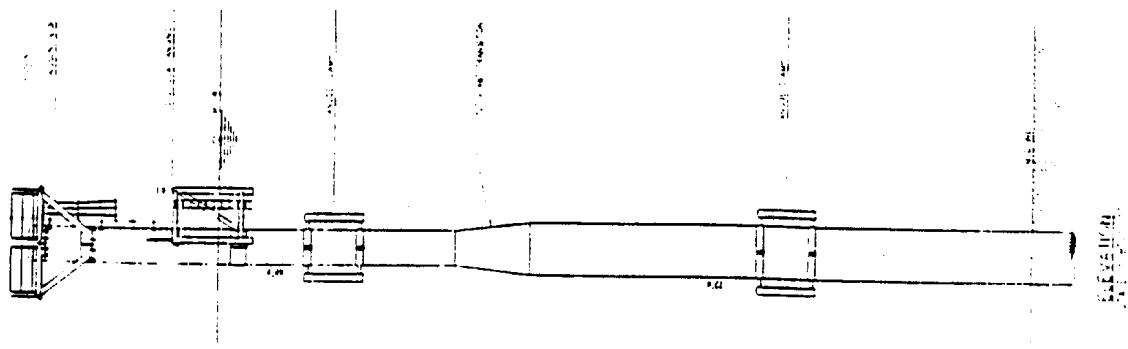

MPC INTERNATIONAL, INC. <small>MARSHALL FIELD</small>		OEDC EXPLORATION & PRODUCTION, I.P. <small>S.A. DE MEXICO</small>	
PROJECT NO. _____ SHEET NO. _____		GENERAL ARRANGEMENT	
DATE _____		DRAWN BY _____	
CHECKED BY _____		APPROVED BY _____	

BEST AVAILABLE COPY

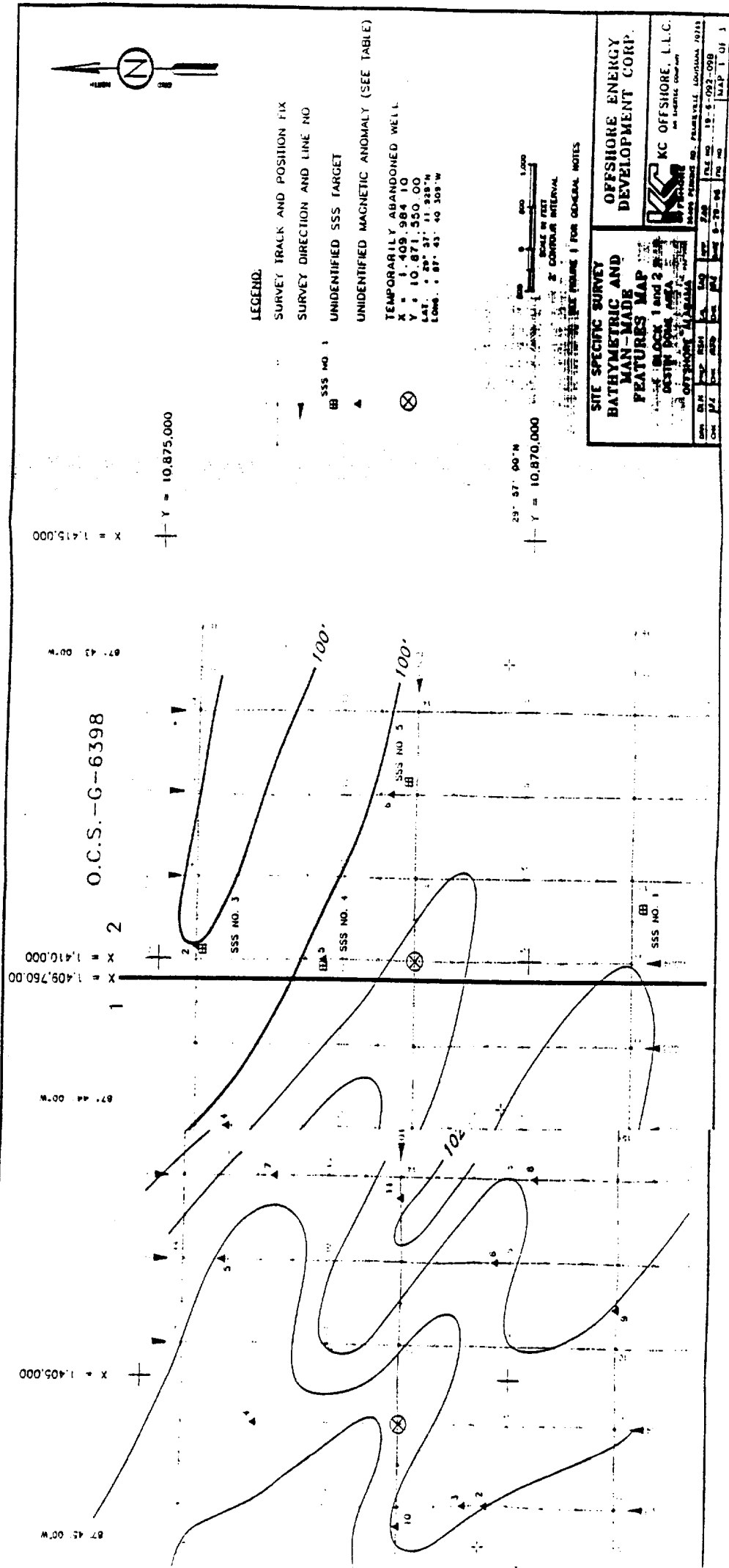

ATTACHMENT D

Environmental Sensitivities Map 1

ENVIRONMENTAL SENSITIVITIES KEY
 REFERENCE: U.S. FISH & WILDLIFE

- Reefs
- ⊗ Fish
- ⊗ Invertebrates
- ⊗ Reptiles & Amphibians
- ⊗ Mammals
- ⊗ Raptors
- ⊗ Seabirds
- ⊗ Shorebirds
- ⊗ Songbirds
- ⊗ Wading Birds
- ⊗ Waterfowl
- Plants

Ⓜ MORRIS ENVIRONMENTAL, INC.

88°24.0'

88°36.0'

88°48.0'

89°0.0'

CHANDELEUR ISLANDS

BRETON NHR

BRETON NHR

BRETON NHR

E. SIDE OF CHAN. IS.

BRETON NHR

BRETON NHR

BRETON NHR

OF CHANDELEUR IS.

NORTH ISLANDS

NORTH ISLANDS

29°48.0'

GRAND BOSIER IS.

29°36.0'

E. OF CHANDELEUR IS.

SE OF CHANDELEUR IS.

BEST AVAILABLE COPY

E. OF CURFEW ISLAND



GULF OF MEXICO

Environmental Sensitivities Map 2

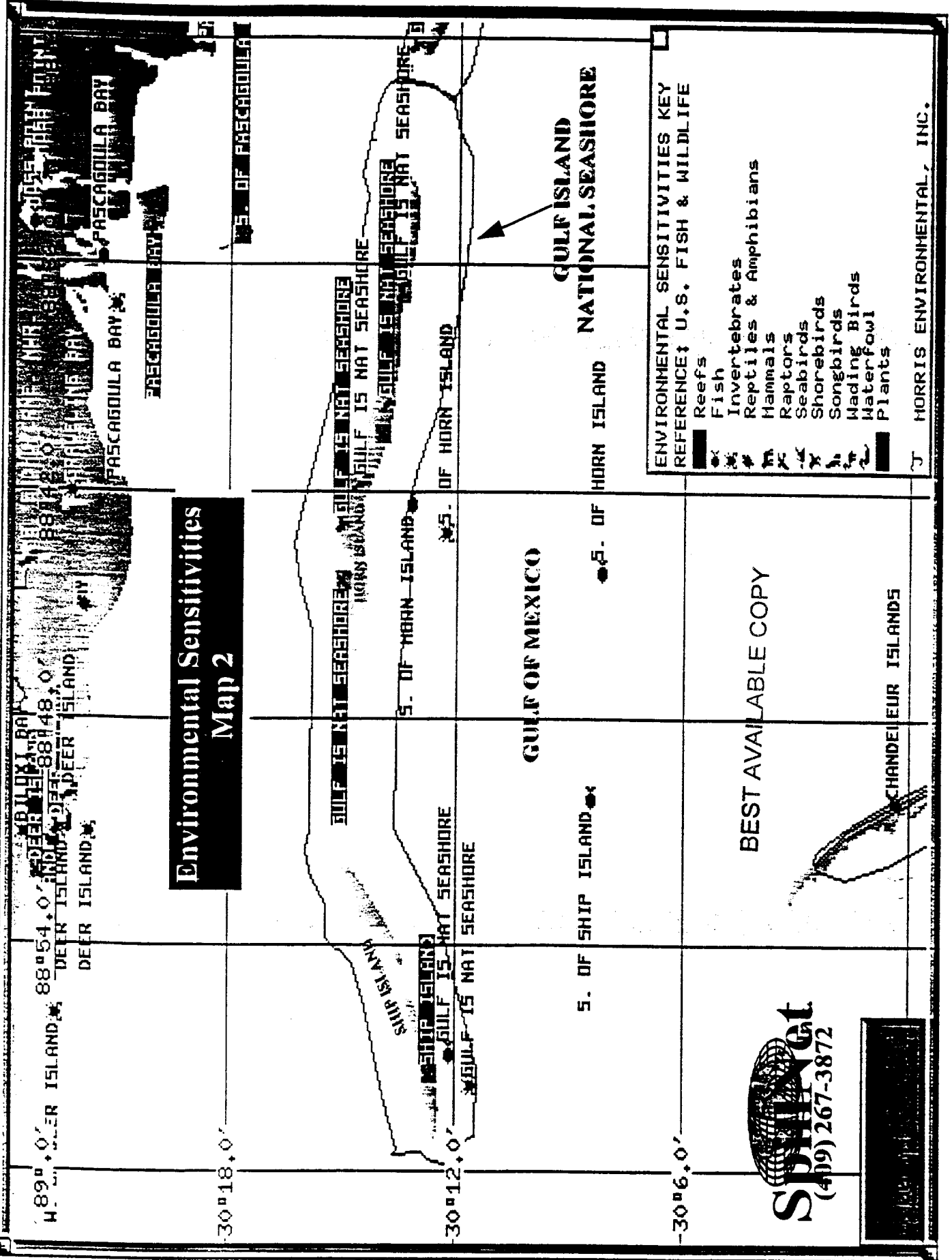

ENVIRONMENTAL SENSITIVITIES KEY
REFERENCE: U.S. FISH & WILDLIFE

- Reefs
- Fish
- Invertebrates
- Reptiles & Amphibians
- Mammals
- Raptors
- Seabirds
- Shorebirds
- Wading Birds
- Waterfowl
- Plants

MORRIS ENVIRONMENTAL, INC.

BEST AVAILABLE COPY

SPRINT
(409) 267-3872



88°56.4'

88°52.8'

88°49.2'

88°45.6'

ENVIRONMENTAL SENSITIVITIES KEY

REFERENCE: U.S. FISH & WILDLIFE

Reefs

Fish

Invertebrates

Reptiles & Amphibians

Mammals

Raptors

Seabirds

Shorebirds

Songbirds

Mating Birds

Waterfowl

Plants

BEST AVAILABLE COPY

HORRIS ENVIRONMENTAL, INC.

**Environmental Sensitivities
Map 3**

75. ENDAL CRANE NHR

75. ENDAL CRANE NHR

CRANE

MISSISSIPPI
CRANE NHR

PORT BAYOU

DEER ISLAND

BILLOXI BAY

BILLOXI BAY

OCEAN SPRINGS
OCEAN SPRINGS

BILLOXI BAY

DEER ISLAND

DEER ISLAND

DEER ISLAND

DEER ISLAND

DEER ISLAND

ISLAND

GULF IS NAT SEASHORE
GULF IS NAT SEASHORE
GULF IS NAT SEASHORE

GULF ISLAND
NATIONAL SEASHORE

BILLOXI BAY

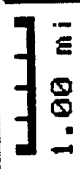

W. OF DEER ISLAND

Environmental Sensitivities Map 4

ENVIRONMENTAL SENSITIVITIES KEY
REFERENCE: U.S. FISH & WILDLIFE

- XXXX Reefs
- Fish
- Invertebrates
- △ Reptiles & Amphibians
- ◇ Mammals
- ▽ Raptors
- ▲ Seabirds
- Shorebirds
- Songbirds
- Wading Birds
- Waterfowl
- Plants

MORRIS ENVIRONMENTAL, INC.

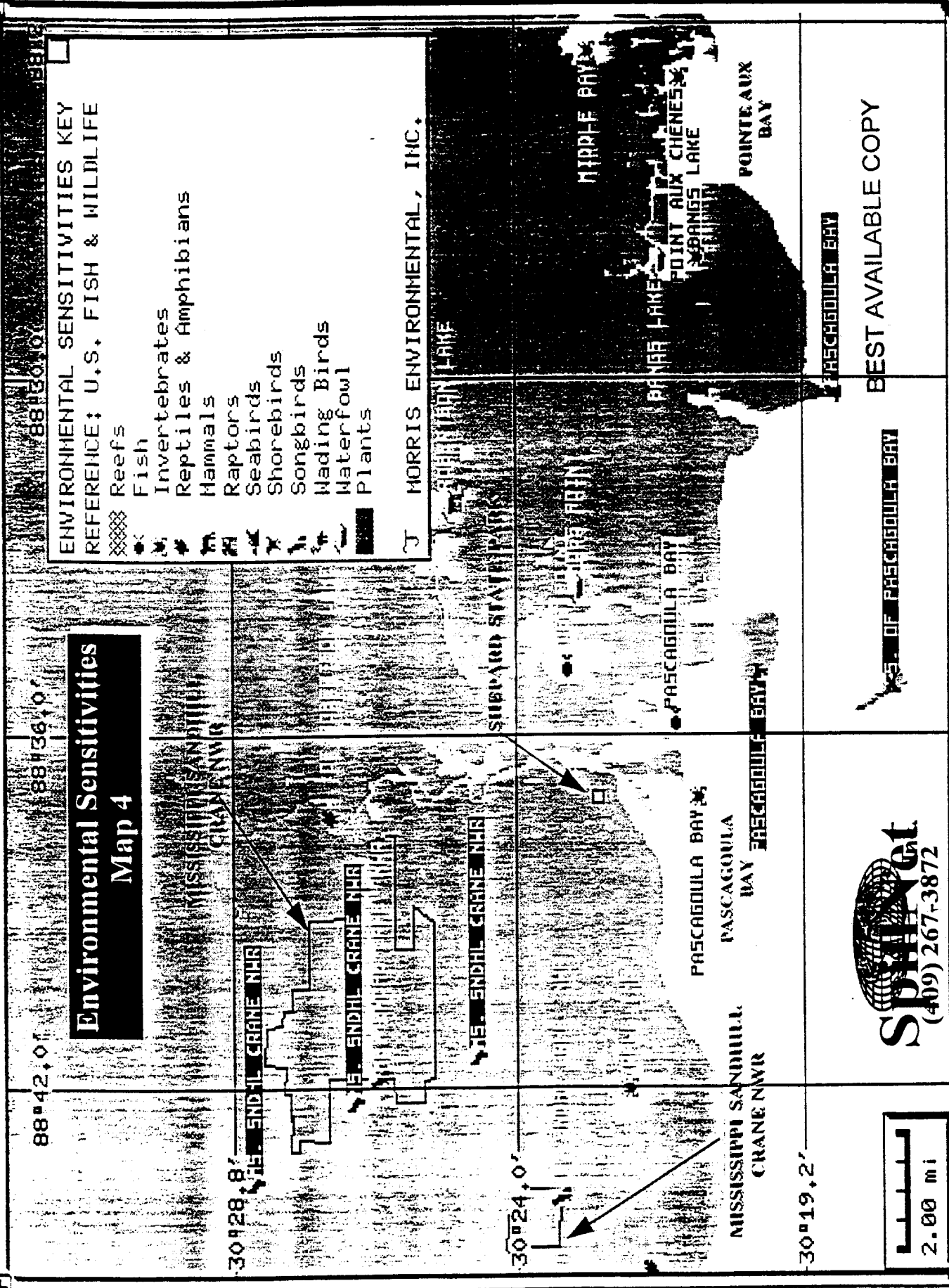

BEST AVAILABLE COPY

Environmental Sensitivities Map 5

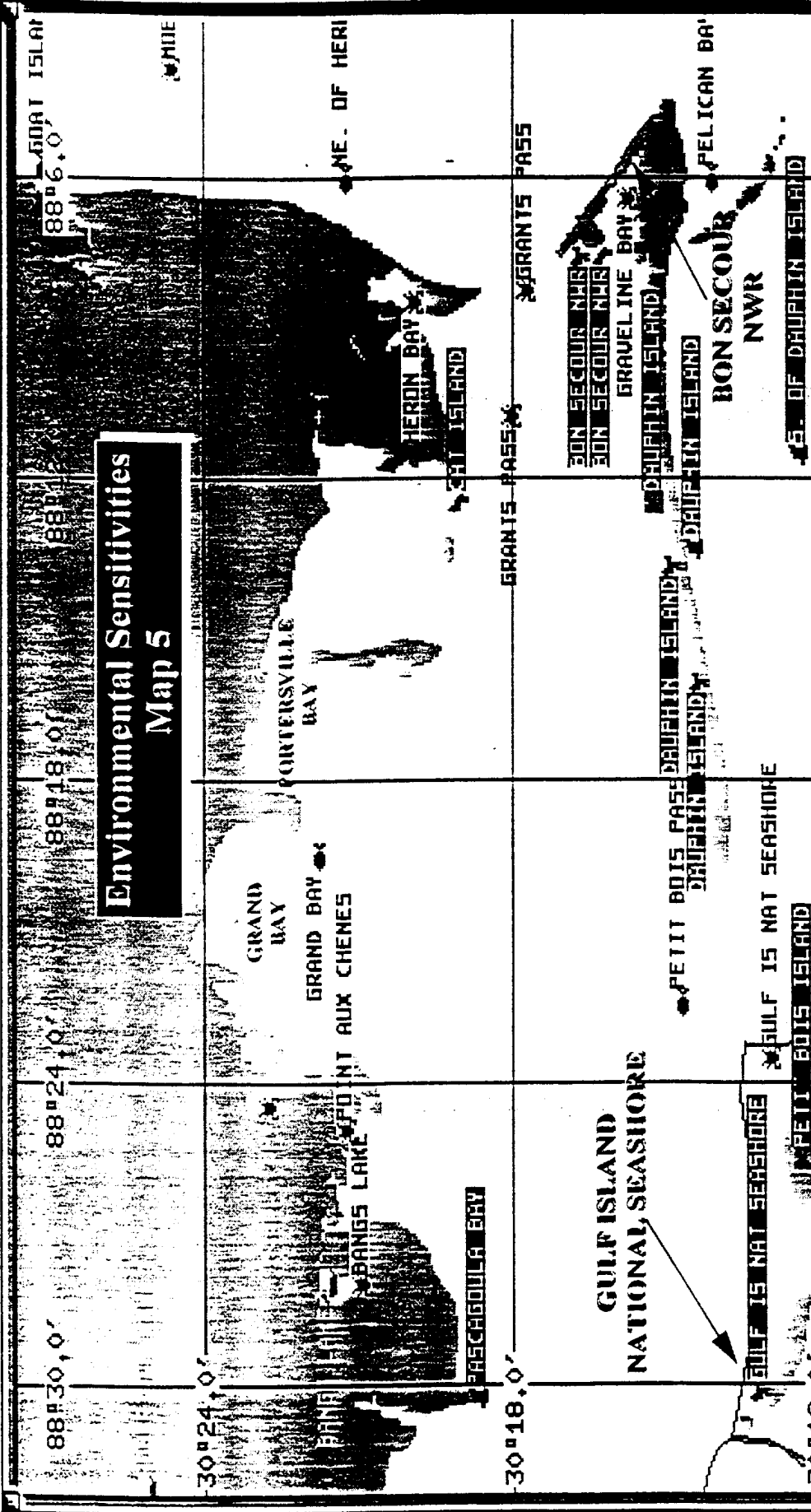

ENVIRONMENTAL SENSITIVITIES KEY
REFERENCE: U.S. FISH & WILDLIFE

- Reefs
- Fish
- Invertebrates
- Reptiles & Amphibians
- Mammals
- Raptors
- Seabirds
- Shorebirds
- Songbirds
- Wading Birds
- Waterfowl
- Plants

GULF OF MEXICO

BEST AVAILABLE COPY

SPRING
(409) 267-3872

MORRIS ENVIRONMENTAL, INC.

30° 24' 0"

86° 0' 0"

87° 54' 0"

Environmental Sensitivities Map 6

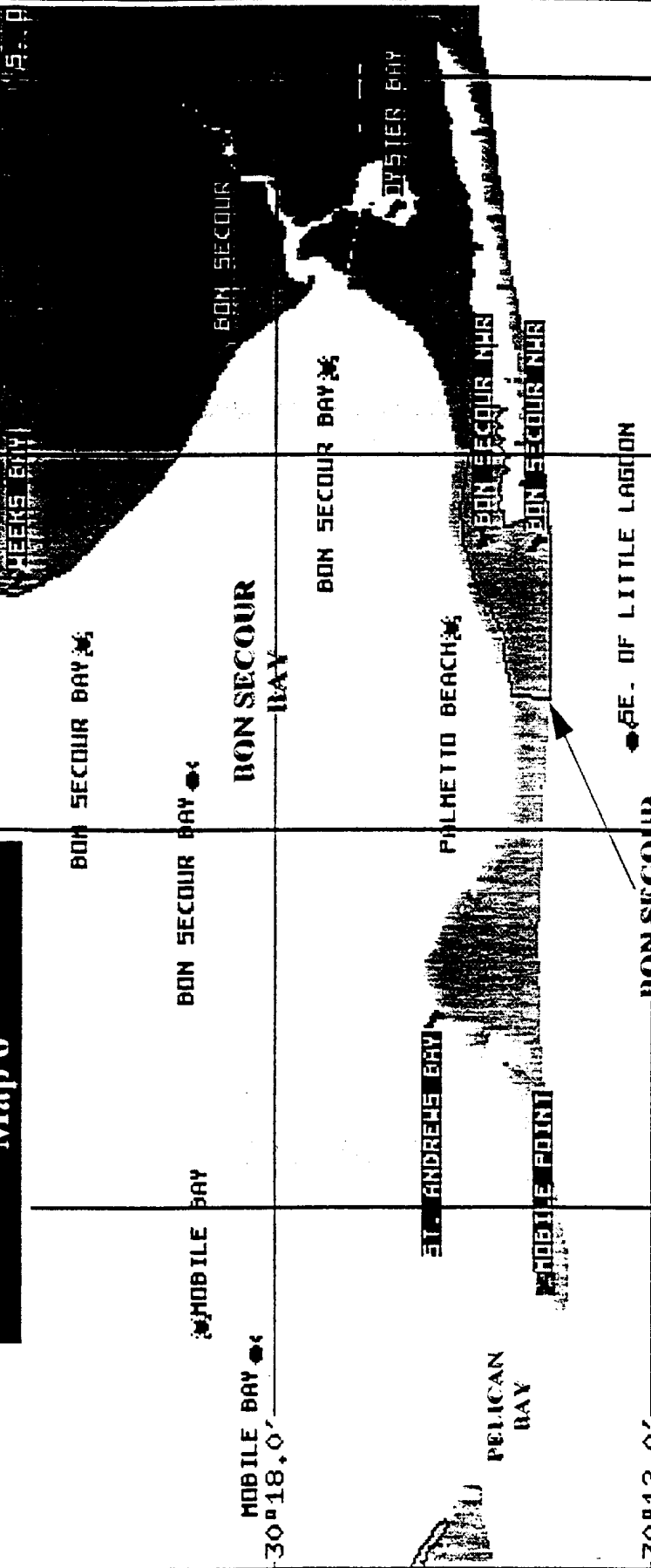

ENVIRONMENTAL SENSITIVITIES KEY
REFERENCE: U.S. FISH & WILDLIFE

■	Reefs
○	Fish
✕	Invertebrates
✕	Reptiles & Amphibians
✕	Mammals
✕	Raptors
✕	Seabirds
✕	Shorebirds
✕	Songbirds
✕	Wading Birds
✕	Waterfowl
■	Plants

MORRIS ENVIRONMENTAL, INC.

BEST AVAILABLE COPY

GULF OF MEXICO

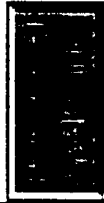

Environmental Sensitivities Map 7

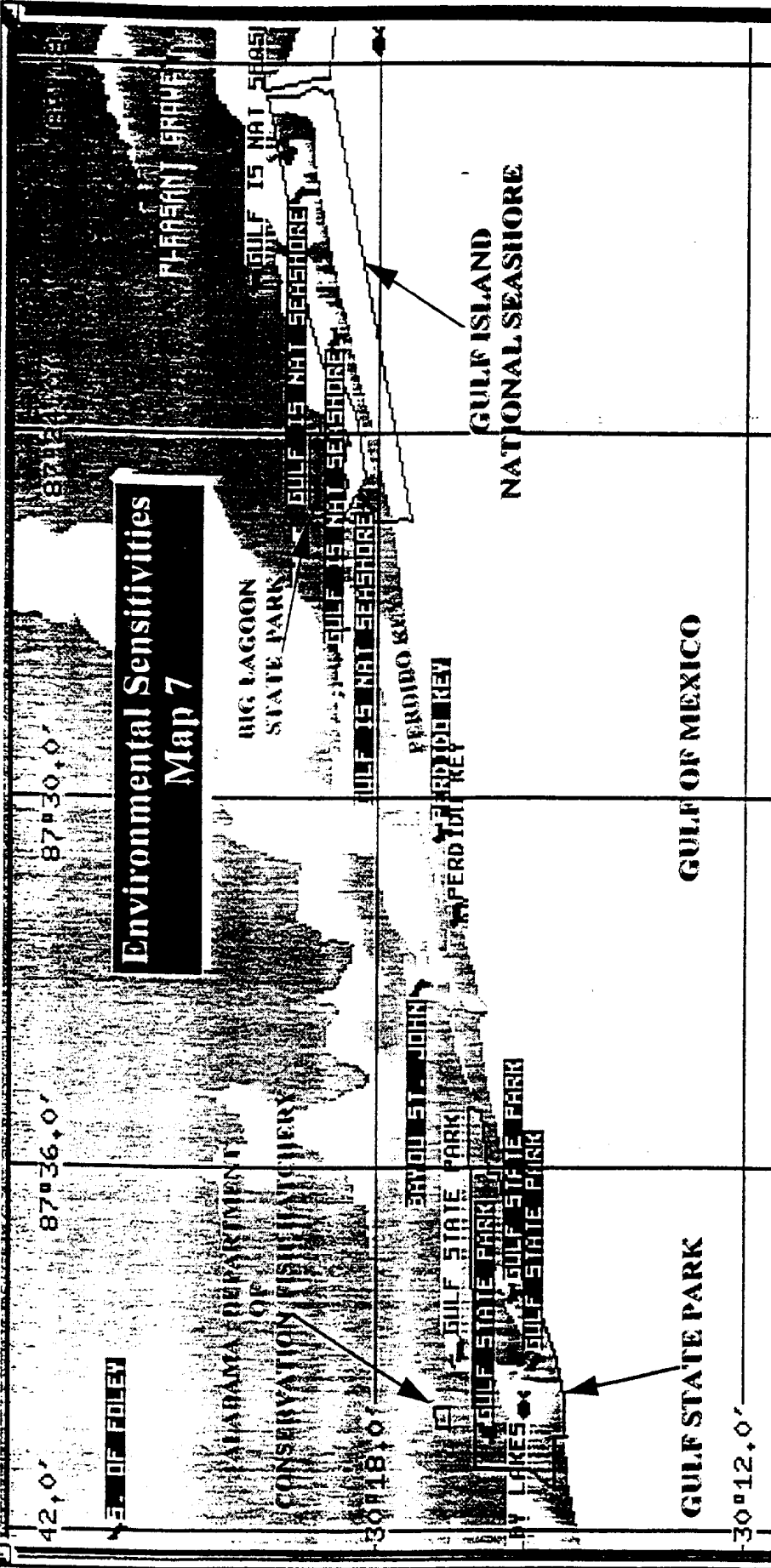

ENVIRONMENTAL SENSITIVITIES KEY
REFERENCE: U.S. FISH & WILDLIFE

- Reefs
- Fish
- Invertebrates
- Reptiles & Amphibians
- Mammals
- Raptors
- Seabirds
- Shorebirds
- Songbirds
- Wading Birds
- Waterfowl
- Plants

J MORRIS ENVIRONMENTAL, INC.

BEST AVAILABLE COPY

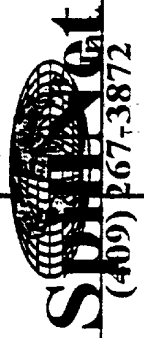

**Environmental Sensitivities
Map 8**

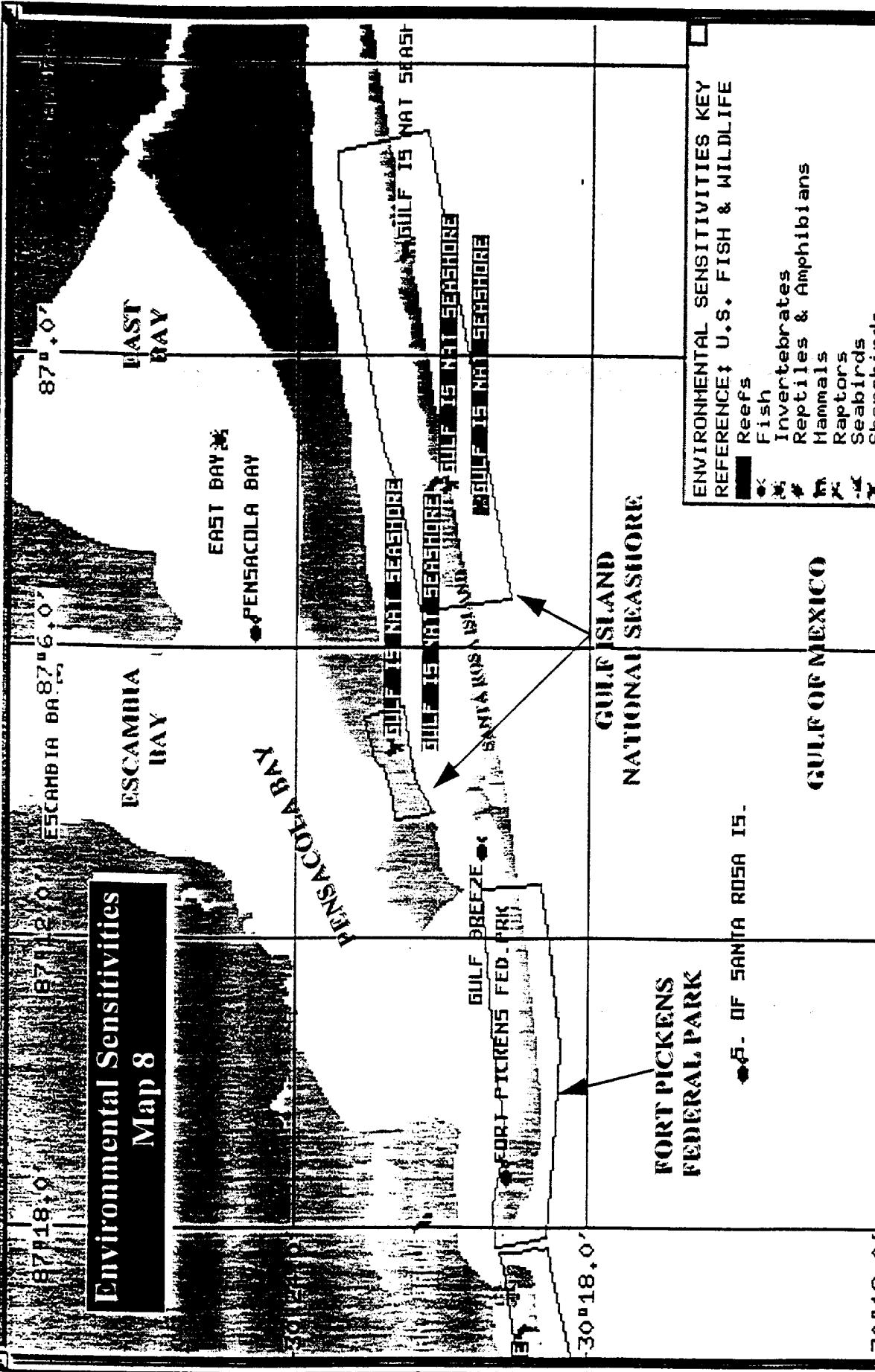

ENVIRONMENTAL SENSITIVITIES KEY
 REFERENCE: U.S. FISH & WILDLIFE

- Reefs
- Fish
- Invertebrates
- Reptiles & Amphibians
- Mammals
- Raptors
- Seabirds
- Shorebirds
- Songbirds
- Wading Birds
- Waterfowl
- Plants

BEST AVAILABLE COPY



J MORRIS ENVIRONMENTAL, INC.

J. Connor Consulting, Inc.



24-Sep-96

AIR QUALITY REVIEW

COMPANY: OEDC EXPLORATION & PRODUCTION, L.P.
AREA: DESTIN DOME
BLOCK: BLOCKS 1 & 2
LEASE: OCS-G 6397/6398
RIG: JACKUP
WELLS: #1 AND #1
LATITUDE: VARIOUS
LONGITUDE: VARIOUS

BEST AVAILABLE COPY

COMPANY CONTACT: JOSEPH L. SAVOY

TELEPHONE NO.: (713) 364-0033

REMARKS: THIS INITIAL JOINT DEVELOPMENT OPERATIONS COORDINATION DOCUMENT PROVIDES FOR THE COMPLETION OF TWO EXISTING TEMPORARILY ABANDONED WELLS (LEASE OCS-G 6397, WELL NO. 1 AND LEASE OCS-G 6398, WELL NO. 1) AND COMMENCEMENT OF PRODUCTION.

PRODUCED HYDROCARBONS FROM WELL NO. 1 IN DESTIN DOME BLOCK 2 WILL FLOW FULL WELL STREAM VIA A PROPOSED 4-INCH LEASE TERM PIPELINE TO CAISSON NO. 1 IN DESTIN DOME BLOCK 1 WHERE IT WILL BE COMBINED WITH FULL-WELL STREAM PRODUCTION FROM WELL NO. 1. THE COMBINED PRODUCED HYDROCARBONS FROM THESE TWO LEASES WILL THEN BE TRANSPORTED VIA A PROPOSED 8-INCH RIGHT-OF-WAY PIPELINE TO OEDC'S EXISTING A PLATFORM IN MOBILE BLOCK 960.

THE PROJECTED AIR EMISSIONS PROVIDE FOR THE USE OF LOW SULPHUR FUEL (0.05%).

AIR EMISSION CALCULATIONS

GULF OF MEXICO AIR EMISSION CALCULATIONS

General

This document (MMS.WK3) was prepared through the cooperative efforts of those professionals in the oil industry including the API/OOC Gulf of Mexico Air Quality Task Force, who deal with air emission issues. Exploration (POE) and Development, Operations, Coordination Documents (DOCD) approved by the Minerals Management Service (MMS). It is intended to be thorough but flexible to meet the needs of different operators. This first sheet gives the basis for the emission factors used in the emission spreadsheet as well as some general instructions. This file contains 8 sheets: A,B,C,D,E,F,G,& H. A is the Instruction Sheet, B is the Title Sheet, C is the Factors Sheet, D,E,F, & G are the Emission Spreadsheets and H is the Summary Sheet. These sheets will describe and calculate emissions from an activity.

Title Sheet

The Title Sheet requires input of the company's name, area, block, OCS-G number, platform and/or well(s) in the necessary lines. This data will automatically be transferred to the spreadsheet and summary sheet.

BEST AVAILABLE COPY

Factor Sheet

The emission factors were compiled from the latest AP-42 references or from industry studies if no AP-42 reference was available. Factors can be revised as more data becomes available. A change to this Factor Sheet will be automatically changed in Emission Spreadsheet.

The basis for the factors is as follows:

1. NG Turbines Fuel usage scf/hr = HP X 9.524 (10,000 btu/HP-hr / 1050 btu/scf)
2. NG Engines Fuel usage scf/hr = HP X 7.143 (7,500 btu/HP-hr / 1050 btu/scf)
3. Diesel Fuel usage gals/hr = HP X 0.0483 (7,000 btu/HP-hr / 145,000 btu/gal)

Emission Factors

Natural Gas Prime Movers

1. TNMOC refers to total non-methane organic carbon emissions and these can be assumed equivalent to VOC emissions.
2. The sulfur content assumed is 2000 grains/mmscf (3.33 ppm). If your concentration is different then ratio your emission factor up or down.

Diesel-Fired Prime Movers

1. Diesel sulfur level 0.4% by wt
2. For boats use > 600 HP factors based on AP-42 Vol. II, Table II-3-3.
Those figures closely match the above values. Include only the emissions from the boats within 25 mile radius of the well/platform.
3. For diesel engines <600 HP VOC emissions equal total HC emissions; for diesel engines >600 HP VOC emissions equal non-methane HC emissions.

AIR EMISSION CALCULATIONS

Heaters/Boilers/Firetubes/NG-Fired

1. NG Sulfur content is 2000 grains per million cu ft
2. VOCs emissions based on total non-methane HCs

Gas Flares

1. Flare is non-smoking
2. 1050 btu/cu. ft. for NG heating value
3. The sulfur content assumed is 2000 grains/mmscf (3.33 ppm). If your concentration is different then ratio your emission factor up or down or you may use the following formula

$$\text{H2S flared (lbs/hr)} = \text{Gas flared (cu ft/hr)} \times \text{ppm H2S} \times 10^6 \times 34/379$$

$$\text{SOx emis (lbs/hr)} = \text{H2S flared (lbs/hr)} \times 64/34$$

Liquid Flares

1. Assume 1% by wt Sulfur maximum in the crude oil.
2. VOC equals non-methane HCs
3. Particulate emissions assumes Grade 5 oil.

BEST AVAILABLE COPY

Tanks

1. Tank emissions assumes uncontrolled fixed roof tank.

Fugitives

1. Fugitives are based on the 1993 Star Environmental Report. It requires that you count or estimate your components.

Glycol Dehydrator Vent

1. The dehydrated gas rate in SCF/HR must be entered in the spreadsheet. The emission factor is from the compilation of the Louisiana Survey and an average emissions per gas rate.

Gas Venting

1. The emission factor is based on venting unburned natural gas of average weight.

Emissions Spreadsheet

The emissions from an operation should be presented for a calendar year (1994, 1995, etc.). The operation may include drilling only or drilling in conjunction with other activities such as pipeline installation or production operations. For the first year use sheet D, for the second year use sheet E, third use F, fourth use G and if you need more you will have to insert a sheet and copy the spreadsheet to the new sheet. The year (CELL D:A38) should be changed and the different operating parameters entered to calculate revised emissions for that subsequent year. The spreadsheet will calculate maximum fuel usage (UNIT/HR) using the known horsepower. It will assume maximum fuel usage is equal to actual fuel

AIR EMISSION CALCULATIONS

(UNIT/DAY) usage unless the actual fuel usage is known. If so, insert actual fuel usage in appropriate column. The emissions will be calculated as follows:

Emission rate (lb/hr) = (HP or fuel rate) X Emission Factor (Potential to emit)

Emissions (tpy)=Emission rate (lb/hr) X load factor(Act Fuel/Max Fuel) X hrsX daysX ton/2000 lbs
(Actual emissions)

To customize the spreadsheet for your application you may want to delete lines for non-applicable equipment/activities or you can input "0" for the HP of equipment that does not apply. You may also need to copy/insert an entire line if more than one similiar type of equipment is present.

Also, the production equipment can be customized further by adding the use of the equipment behind each type of engine, i.e.,

Turbine
Turbine - Gas Compressor

Burner
Burner - Line Heater

BEST AVAILABLE COPY

Summary Sheet

The Summary Sheet is designed to show a proposed estimate of emissions from an activity over a future period of time. In this example ten years was chosen. Each row links to the corresponding emission calculation spreadsheet for that year. For example, Row 7 of the summary corresponds to the annual totals from Sheet D. Row 8 links to the second emission calculation spreadsheet, Row 9 to the third and Row 10 to the fourth. Row 11 - 16 will carry down the emissions from the last spreadsheet with an emission rate greater than zero. The Summary Sheet will always carry down the last non-zero emission total. For example, if emission calculations are done for the years 1994 and 1995, then the the 1995 total will be carried down through the year 2003. Row 17 of the summary sheet reflects the allowable for the air quality review exemption determination. If more or less years are needed you will have to modify the spreadsheet.

Print Instructions

The table below lists macros that were written to print sheets A, C, D, E, F, G, & H.

- VA - This macro prints 3 pages of instructions (sheet A).
- VC - This macro prints the emissions factors sheet (sheet C).
- VD - This macro prints the emissions calculations sheet (sheet D).
- VE - This macro prints the emissions calculations sheet (sheet E).
- VF - This macro prints the emissions calculations sheet (sheet F).
- VG - This macro prints the emissions calculations sheet (sheet G).
- VH - This macro prints the emissions calculations sheet (sheet H).
- VX - This macro prints all sheets - A, C, D, E, F, G, & H.

To run one of these macros, hold down ALT and press the letter in the macro range name. For example, to run the macro VA, press ALT-a.

COMPANY	AREA	BLOCK	LEASE	RIG	WELL
OEDC EXPLORATION & PRODUCTION, L	DESTIN DOME	BLOCKS 1 & 2	OCS-G 6397/6398	JACKUP	#1 AND #1

Year	Emitted Substance				
	TSP	SOx	NOx	HC	CO
1997	2.91	2.26	133.21	4.15	29.06
1998	0.37	0.29	17.12	0.78	3.74
1999	0.37	0.29	17.12	0.78	3.74
2000	0.37	0.29	17.12	0.78	3.74
2001	0.37	0.29	17.12	0.78	3.74
2002	0.37	0.29	17.12	0.78	3.74
Allowable	666.00	666.00	666.00	666.00	25302.83

BEST AVAILABLE COPY

COMPANY	AREA	BLOCK	LEASE	RIG	WELL	LATITUDE	LONGITUDE	CONTACT	PHONE	REMARKS	TONS PER YEAR											
											TSP	SOx	NOx	VOC	CO	TSP	SOx	NOx	VOC	CO		
DC EXPLORATION & PRODUCTION OPERATIONS	DESTIN DOME EQUIPMENT	BLOCKS 1 & 2	OCS-G 6397/6398	MAX FUEL	GAL/HR	SCF/HR	SCF/HR	ACT. FUEL	JACKUP	RIG	WELL #1	LAND #1	RUN TIME	POUNDS PER HOUR								
														TSP	SOx	NOx	VOC	CO	TSP	SOx	NOx	VOC
BILLING	Diesel Engines	HP	MMBTU/HR	SCF/HR	SCF/HR	SCF/D	SCF/D	GAU/D	SCF/D	ACT. FUEL	HR/D	DAYS	TSP	SOx	NOx	VOC	CO	TSP	SOx	NOx	VOC	CO
	PRIME MOVER->600hp diesel	3070	148.28	3558.74	24	30	1.62	1.26	74.38	2.23	16.23	0.58	0.45	26.78	0.80	5.84						
	PRIME MOVER->600hp diesel	3070	148.28	3558.74	24	30	1.62	1.26	74.38	2.23	16.23	0.58	0.45	26.78	0.80	5.84						
	PRIME MOVER->600hp diesel	2200	106.26	2550.24	24	30	1.16	0.90	53.30	1.60	11.63	0.42	0.32	19.19	0.58	4.19						
	VESSELS->600hp diesel	2265	109.40	2625.59	4	30	1.20	0.93	54.88	1.65	11.97	0.07	0.06	3.29	0.10	0.72						
	VESSELS->600hp diesel	2265	109.40	2625.59	8	30	1.20	0.93	54.88	1.65	11.97	0.14	0.11	6.59	0.20	1.44						
	PIPELINE LAY BARGE diesel	5000	241.50	5796.00	24	10	2.64	2.05	121.15	3.63	26.43	0.32	0.25	14.54	0.44	3.17						
	SUPPORT VESSEL diesel	2000	96.60	2318.40	24	10	1.06	0.82	48.46	1.45	10.57	0.13	0.10	5.81	0.17	1.27						
	PIPELINE BURY BARGE diesel	5000	241.50	5796.00	24	10	2.64	2.05	121.15	3.63	26.43	0.32	0.25	14.54	0.44	3.17						
	SUPPORT VESSEL diesel	2000	96.60	2318.40	24	10	1.06	0.82	48.46	1.45	10.57	0.13	0.10	5.81	0.17	1.27						
	DERRICK BARGE diesel	0	0.00	0.00	0	0	0.00	0.00	0.00	0.00	0.00	0.00	0.00	0.00	0.00	0.00						
	MATERIAL TUG diesel	0	0.00	0.00	0	0	0.00	0.00	0.00	0.00	0.00	0.00	0.00	0.00	0.00	0.00						
	RECIP->600hp diesel	0	0.00	0.00	0	0	0.00	0.00	0.00	0.00	0.00	0.00	0.00	0.00	0.00	0.00						
	RECIP->600hp diesel	0	0.00	0.00	0	0	0.00	0.00	0.00	0.00	0.00	0.00	0.00	0.00	0.00	0.00						
	SUPPORT VESSEL diesel	2265	109.40	2625.59	4	30	1.20	0.93	54.88	1.65	11.97	0.07	0.06	3.29	0.10	0.72						
	SUPPORT VESSEL diesel	2265	109.40	2625.59	8	30	1.20	0.93	54.88	1.65	11.97	0.14	0.11	6.59	0.20	1.44						
	TURBINE nat gas	0	0.00	0.00	0	0	0.00	0.00	0.00	0.00	0.00	0.00	0.00	0.00	0.00	0.00						
	RECIP 2 cycle lean nat gas	0	0.00	0.00	0	0	0.00	0.00	0.00	0.00	0.00	0.00	0.00	0.00	0.00	0.00						
	RECIP 4 cycle lean nat gas	0	0.00	0.00	0	0	0.00	0.00	0.00	0.00	0.00	0.00	0.00	0.00	0.00	0.00						
	RECIP 4 cycle rich nat gas	0	0.00	0.00	0	0	0.00	0.00	0.00	0.00	0.00	0.00	0.00	0.00	0.00	0.00						
	RECIP 4 cycle rich nat gas	0	0.00	0.00	0	0	0.00	0.00	0.00	0.00	0.00	0.00	0.00	0.00	0.00	0.00						
	MISC.	BPD	SCF/HR	COUNT																		
	TANK-	0																				
	FLARE-	0																				
	PROCESS VENT-	0																				
	FUGITIVES-	2400.0				214																
	GLYCOL STILL VENT-	0																				
	OIL BURN	0																				
	GAS FLARE	0																				
	1997 YEAR TOTAL						16.60	12.88	760.79	22.88	165.99	2.91	2.26	133.21	4.15	29.06						
	EMPTION CALCULATION											666.00	666.00	666.00	666.00	25302.83						
	DISTANCE FROM LAND IN MILES															20.0						

BEST AVAILABLE COPY

COMPANY	AREA	BLOCK	LEASE	PLATFORM	WELL #1 AND #1	LATITUDE	LONGITUDE	CONTACT	PHONE	REMARKS	TONS PER YEAR															
											TSP	SOx	NOx	VOC	CO											
OPERATIONS	EQUIPMENT Diesel Engines Nat. Gas Engines	BLOCKS 1 & 2	OCS-G 6397/6398 MAX. FUEL GAL/HR SCF/HR	JACKUP ACT. FUEL GAL/D SCF/D	VARIOUS RUN TIME	VARIOUS	VARIOUS	JOSEPH L. SAVOY	(713) 364-0033		TSP	SOx	NOx	VOC	CO											
											0	0.00	0.00	0.00	0.00											
											0	0.00	0.00	0.00	0.00											
											0	0.00	0.00	0.00	0.00											
											0	0.00	0.00	0.00	0.00											
											0	0.00	0.00	0.00	0.00											
											0	0.00	0.00	0.00	0.00											
											0	0.00	0.00	0.00	0.00											
											0	0.00	0.00	0.00	0.00											
											0	0.00	0.00	0.00	0.00											
PIPELINE	PIPELINE LAY BARGE diesel	0	0.00	0.00	0	0	0.00	0.00	0.00	0.00	TSP	SOx	NOx	VOC	CO											
											0	0.00	0.00	0.00	0.00											
											0	0.00	0.00	0.00	0.00											
											0	0.00	0.00	0.00	0.00											
											0	0.00	0.00	0.00	0.00											
											0	0.00	0.00	0.00	0.00											
											0	0.00	0.00	0.00	0.00											
											0	0.00	0.00	0.00	0.00											
											0	0.00	0.00	0.00	0.00											
											0	0.00	0.00	0.00	0.00											
INSTALLATION	SUPPORT VESSEL diesel	0	0.00	0.00	0	0	0.00	0.00	0.00	0.00	TSP	SOx	NOx	VOC	CO											
											0	0.00	0.00	0.00	0.00											
											0	0.00	0.00	0.00	0.00											
											0	0.00	0.00	0.00	0.00											
											0	0.00	0.00	0.00	0.00											
											0	0.00	0.00	0.00	0.00											
											0	0.00	0.00	0.00	0.00											
											0	0.00	0.00	0.00	0.00											
											0	0.00	0.00	0.00	0.00											
											0	0.00	0.00	0.00	0.00											
FACILITY	DERRICK BARGE diesel	0	0.00	0.00	0	0	0.00	0.00	0.00	0.00	TSP	SOx	NOx	VOC	CO											
											0	0.00	0.00	0.00	0.00											
											0	0.00	0.00	0.00	0.00											
											0	0.00	0.00	0.00	0.00											
											0	0.00	0.00	0.00	0.00											
											0	0.00	0.00	0.00	0.00											
											0	0.00	0.00	0.00	0.00											
											0	0.00	0.00	0.00	0.00											
											0	0.00	0.00	0.00	0.00											
											0	0.00	0.00	0.00	0.00											
PRODUCTION	RECIP-600hp diesel	0	0.00	0.00	0	0	0.00	0.00	0.00	0.00	TSP	SOx	NOx	VOC	CO											
											0	0.00	0.00	0.00	0.00											
											0	0.00	0.00	0.00	0.00											
											2265	109.40	2625.59	2625.59	4	52	1.20	0.93	54.88	1.65	11.97	0.12	0.10	5.71	0.17	1.25
											2265	109.40	2625.59	2625.59	8	52	1.20	0.93	54.88	1.65	11.97	0.25	0.19	11.41	0.34	2.49
											0	0.00	0.00	0.00	0	0	0.00	0.00	0.00	0.00	0.00	0.00	0.00	0.00	0.00	0.00
											0	0.00	0.00	0.00	0	0	0.00	0.00	0.00	0.00	0.00	0.00	0.00	0.00	0.00	0.00
											0	0.00	0.00	0.00	0	0	0.00	0.00	0.00	0.00	0.00	0.00	0.00	0.00	0.00	0.00
											0	0.00	0.00	0.00	0	0	0.00	0.00	0.00	0.00	0.00	0.00	0.00	0.00	0.00	0.00
											0	0.00	0.00	0.00	0	0	0.00	0.00	0.00	0.00	0.00	0.00	0.00	0.00	0.00	0.00
DRILLING	WELL TEST	0	0	0	0	0	0.00	0.00	0.00	0.00	TSP	SOx	NOx	VOC	CO											
											0	0.00	0.00	0.00	0.00											
											0	0.00	0.00	0.00	0.00											
											0	0.00	0.00	0.00	0.00											
											0	0.00	0.00	0.00	0.00											
											0	0.00	0.00	0.00	0.00											
											0	0.00	0.00	0.00	0.00											
											0	0.00	0.00	0.00	0.00											
											0	0.00	0.00	0.00	0.00											
											0	0.00	0.00	0.00	0.00											
1998 YEAR TOTAL							2.39	1.86	109.76	3.35	23.95	0.37	0.29	17.12	0.78	3.74										
																	666.00	666.00	666.00	666.00	666.00					
																	666.00	666.00	666.00	666.00	666.00					
																	666.00	666.00	666.00	666.00	666.00					
																	666.00	666.00	666.00	666.00	666.00					
																	666.00	666.00	666.00	666.00	666.00					
																	666.00	666.00	666.00	666.00	666.00					
																	666.00	666.00	666.00	666.00	666.00					
																	666.00	666.00	666.00	666.00	666.00					
																	666.00	666.00	666.00	666.00	666.00					
EXEMPTION CALCULATION	DISTANCE FROM LAND IN MILES	20.0																								
																	666.00	666.00	666.00	666.00	666.00					
																	666.00	666.00	666.00	666.00	666.00					
																	666.00	666.00	666.00	666.00	666.00					
																	666.00	666.00	666.00	666.00	666.00					
																	666.00	666.00	666.00	666.00	666.00					
																	666.00	666.00	666.00	666.00	666.00					
																	666.00	666.00	666.00	666.00	666.00					
																	666.00	666.00	666.00	666.00	666.00					
																	666.00	666.00	666.00	666.00	666.00					

BEST AVAILABLE COPY

Fuel Usage Conversion Factors	Natural Gas Turbines		Natural Gas Engines		Diesel Recip. Engine		REF.	DATE
	SCF/hp-hr	9.524	SCF/hp-hr	7.143	GAL/hp-hr	0.0483		
							AP42 3.2-1	4/76 & 8/84

Equipment/Emission Factors	units	TSP	SOx	NOx	VOC	CO	REF.	DATE
NG Turbines	gms/hp-hr		0.00247	1.3	0.01	0.83	AP42 3.2-2	4/93
NG 2-cycle lean	gms/hp-hr		0.00185	11	0.43	1.5	AP42 3.2-2	4/93
NG 4-cycle lean	gms/hp-hr		0.00185	12	0.72	1.6	AP42 3.2-2	4/93
NG 4-cycle rich	gms/hp-hr		0.00185	10	0.14	8.6	AP42 3.2-2	4/93
Diesel Recip. < 600 hp.	gms/hp-hr	1	0.116	14	1.12	3.03	AP42 3.3-1	4/93
Diesel Recip. > 600 hp.	gms/hp-hr	0.24	0.18625	11	0.33	2.4	AP42 3.4-1	4/93
NG Heaters/Boilers/Burners	lbs/mmscf	5	0.6	140	2.8	35	AP42 1.4-1	4/93
NG Flares	lbs/mmscf		0.57	71.4	60.3	388.5	AP42 11.5-1	9/91
Liquid Flaring	lbs/bbls	0.42	6.6	2.3	0.01	0.21	AP421.3-1	4/93
Tank Vapors	lbs/bbl				0.03		E&P Forum	1/93
Fugitives	lbs/hr/comp.				0.000025		API Study	12/93
Glycol Dehydrator Vent	lbs/mmscf				6.6		La. DEQ	1991
Gas Venting	lbs/scf				0.0034			

BEST AVAILABLE COPY

OEDC EXPLORATION AND PRODUCTION, L.P.

ENVIRONMENTAL ASSESSMENT REPORT

DESTIN DOME BLOCKS 1 AND 2

LEASES OCS-G 6397/6398

OFFSHORE, ALABAMA

BEST AVAILABLE COPY

Prepared by:

J. Connor Consulting, Inc.
16225 Park Ten Place, Suite 500
Houston, TX 77084
(713) 578-3388

September 21, 1996

TABLE OF CONTENTS

BEST AVAILABLE COPY

I.	DESCRIPTION OF THE PROPOSED ACTION	
A.	GENERAL	1
B.	LEASE STIPULATIONS	1
C.	ONSHORE SUPPORT FACILITIES	2
D.	CONTINGENCY PLANS	3
E.	STATE CERTIFICATION	4
F.	DISCHARGES AND EMISSIONS	4
II.	DESCRIPTION OF THE AFFECTED ENVIRONMENT	
A.	PHYSICAL ENVIRONMENT	6
1.	Environmental Geology and Hazards	6
2.	Air Quality	7
3.	Physical Oceanography	8
	Hydrography	9
	-Sea Surface Temperature	11
	-Vertical Temperature	13
	-Surface Salinity	13
	-Vertical Salinity	14
	-Hydrography Variations at Time Scales of Days	14
	Tidal Regime	15
	Sea State	16
	Regional Circulation	17
4.	Water Quality	18

B.	BIOLOGICAL ENVIRONMENT	20
1.	<i>Coastal Habitat</i>	20
	- <i>Coastal Marshes</i>	21
	- <i>Coastal Wetlands</i>	22
	- <i>Seagrasses</i>	22
2.	<i>Offshore Habitat</i>	23
3.	<i>Endangered, Threatened and/or Protected Species</i>	24
	- <i>Sea Turtles</i>	24
	- <i>Birds</i>	25
	- <i>Beach Mice</i>	26
	- <i>Large Whales</i>	26
	- <i>Other Marine Mammals</i>	26
4.	<i>Non-Endangered Birds</i>	27
5.	<i>Commercial Fisheries</i>	29
C.	SOCIOECONOMIC CONDITIONS AND OTHER CONCERNS	31
1.	<i>Economic and Demographic Conditions</i>	31
2.	<i>Recreation</i>	32
3.	<i>Cultural Resources</i>	33
4.	<i>Navigation</i>	35
5.	<i>Pipelines and Cables</i>	36
6.	<i>Ocean Dumping</i>	36
III.	POTENTIAL ENVIRONMENTAL EFFECTS	
A.	PHYSICAL ENVIRONMENT	38
1.	<i>Effects from Potential Geological Hazards</i>	38

2.	<i>Effects on Air Quality</i>	38
3.	<i>Effects on Water Quality</i>	39
B.	<i>BIOLOGICAL ENVIRONMENT</i>	42
1.	<i>Effects on Coastal Habitat</i>	42
	<i>-Effects on Wetlands and Seagrasses</i>	43
2.	<i>Effects on Offshore Habitats</i>	45
3.	<i>Effects on Endangered, Threatened and/or Protected Species</i>	46
	<i>-Effects on Sea Turtles</i>	46
	<i>-Effects on Birds</i>	46
	<i>-Effects of Hydrocarbon Spills on all Birds</i>	47
	<i>-Effects on Large Whales</i>	48
	<i>-Effects on Other Marine Mammals</i>	48
	<i>-Effects on Beach Mice</i>	49
	<i>-Effects on Gulf Sturgeon</i>	49
4.	<i>Effects on Commercial Fisheries</i>	50
C.	<i>SOCIOECONOMIC CONDITIONS AND OTHER CONCERNS</i>	51
1.	<i>Effects on Economic and Demographic Conditions</i>	51
	<i>-Effects on Local Employment</i>	51
	<i>-Effects on Local Population and Industry Centers</i>	52
2.	<i>Effects on Land Use</i>	53
3.	<i>Effects on Recreation/Tourism</i>	54
4.	<i>Effects on Cultural Resources</i>	54
5.	<i>Effects on Navigation</i>	55
6.	<i>Effects from the Military Warning Area</i>	55

Table of Contents (Continued)

7. *Effects on Other Commercial or Mineral Uses* 55

8. *Effects from Ocean Dumping* 55

D. *ACCIDENTAL HYDROCARBON DISCHARGES* 55

1. *Spill Response Strategies* 55

2. *Spill Response Training* 56

3. *Notification Procedures* 56

4. *Area Services and Contractors* 56

E. *SUMMARY* 57

BIBLIOGRAPHY

BEST AVAILABLE COPY

ATTACHMENTS

I. DESCRIPTION OF PROPOSED ACTION

BEST AVAILABLE COPY

A. GENERAL

The proposed Initial Joint Development Operations Coordination Document provides for the completion of the existing temporarily abandoned wells, installation of a freestanding caisson over the surface location of each well and commencement of production.

The produced hydrocarbons from Well No. 1 in Destin Dome Block 2 will flow full-well stream via a proposed 4-inch lease term pipeline to Caisson No. 1 where it will be combined with full-well stream production from Well No. 1, Destin Dome Block 1. The combined produced hydrocarbons from these two leases will then be transported via a proposed 8-inch right-of-way pipeline to OEDC's existing A platform in Mobile Block 960 for processing.

The proposed activities under this Initial Joint Development Operations Coordination Document for Destin Dome Blocks 1 and 2 are scheduled to commence on or about March 1, 1997.

B. LEASE STIPULATIONS

Oil and gas exploration/development activities on the OCS are subject to stipulations developed before the lease sale and would be attached to the lease instrument, as necessary, in the form of mitigating measures. The MMS is responsible for ensuring full compliance with stipulations.

Lease Stipulation No. 1 attached to the subject leases requires preparation of a Cultural Resources Report assessing potential existence of any cultural resources. As stated in Minerals Management Service Letter to Lessees (LTL) dated September 5, 1995, effective November 21, 1994, a final rule was published in the Federal Register which added a new section, 30 CFR 250.26, titled "Archaeological Reports and Surveys", to Minerals Management Service Operating Regulations. This rule was developed to convert the requirements contained in Stipulation No. 1 into regulations which apply to all leases located with areas determined as having high probability for the occurrence of archaeological resources. The subject leases were designated by the Minerals Management Service as areas having a high probability for prehistoric archaeological resources on the OCS. Therefore, an archaeological resources report

BEST AVAILABLE COPY

is required based on data from prehistoric site remote-sensing surveys.

Lease Stipulation No. 4 requires control of electromagnetic emissions emanating from individual designated defense warning areas in accordance with requirements specified by the commander of the command headquarters to the degree necessary to prevent damage to, or unacceptable interference with, Department of Defense flight, testing or operation activities conducted within the warning area.

Destin Dome Blocks 1 and 2 are located within Military Area (W-155A). OEDC will enter into an agreement with the commander of the Eglin Air Force Base located in Florida for positive control boats and aircraft operating within Military Area (W-155A) during the proposed operations.

C. ONSHORE SUPPORT FACILITIES

Well No. 1 in Destin Dome Blocks 1 and 2 are located approximately 20 miles from the nearest shoreline in water depths ranging from 102 to 107 feet. During completion operations, OEDC will utilize existing onshore facilities located in Theodore, Alabama. This will serve as a port of debarkation for supplies and crews. During production operations, McHugh's Dock in Dauphin Island, Alabama, will serve as the port of debarkation for supplies and crews. No onshore expansion or construction is anticipated with respect to the proposed operations.

The onshore support base is capable of providing the services necessary for the proposed activities. It has 24-hour service, a radio tower with a phone patch, dock space, equipment and supply storage base, drinking and drill water, etc. Support vessels and travel frequency during production activities are as follows:

	<i>COMPLETION</i>	<i>PRODUCTION</i>
Crew Boat	7 Trips Per Week	1 Trip Per Week
Supply Boat	7 Trips Per Week	1 Trip Per Week
Helicopter	1 Trip Per Week	0 Trips Per Week

D. CONTINGENCY PLANS

By letter dated May 1, 1996, Minerals Management Service approved OEDC's regional Oil Spill Contingency Plan (OSCP) annual update.

The OSCP covers all facilities operated by Offshore Energy Development Corporation, Dauphin Island Gathering Partners, OEDC Exploration and Production, L.P. and OEDC, Inc. in the offshore Gulf of Mexico, seaward of the coastline, under the jurisdiction of the Minerals Management Service.

In conducting oil and gas operations in the Gulf of Mexico, OEDC is committed to the prevention of pollution. The focus of OEDC's Spill Response Program is prevention. However, should an oil spill occur, this OSCP is designed to help company employees respond quickly, safely and effectively to reduce damage to property and the environment. Response to an oil spill will require immediate notification to federal and state agencies. It will also require assembly of the Oil Spill Management Team, and possible mobilization of the Oil Spill Response Operating Team and spill response equipment.

OEDC is a member of Clean Gulf Associates. Through this association, all companies listed in OSCP have access to oil spill equipment along the gulf coasts of Louisiana, Alabama, Florida, Mississippi and Texas and would utilize this equipment along with all necessary third party services, as required for the cleanup of a major spill.

Pollution inspection are conducted on all unmanned facilities in accordance with MMS policies. Operations personnel have been instructed to check for pollution frequently during their tour of duty, and in the event pollution is spotted, to identify and shut off the source and make immediate notifications.

Pipeline leaks and rupture events are detectable through the monitoring of operating pressures by personnel at shorebases or producing facilities. Small leaks which may not be detectable through obvious declines in operating pressures are identified through aerial reconnaissance by aircraft or reports from pilots from other companies or patrols by marine vessels. If it is determined that the leaking line is OEDC's, the pipeline would be shut in and the Spill Response Coordinator or one of the Alternates would be contacted. The National Response Center, the Spill Management Team and other company personnel would be contacted and appropriated response actions started.

The Incident Commander and Alternates receive annual classroom training for familiarization with containment and recovery equipment, call-out procedures, the location and intended use of available response equipment, spill reporting procedures and deployment strategies. The Oil Spill Response Operating Team attends annual drills for familiarization with pollution control equipment or operations procedures. Additionally, a Spill Management Team tabletop exercise is also held on an annual basis.

BEST AVAILABLE COPY

E. STATE CERTIFICATION

Issues identified in the Florida and Alabama Coastal Zone Management Program include the following: general coastal use guidelines, levees, linear facilities (pipelines); dredged soil deposition; shoreline modifications, surface alterations, hydrologic and sediment transport modifications; waste disposal; uses that result in the alteration of waters draining into coastal waters; oil, gas or other mineral activities; and air and water quality.

The proposed activities comply with Florida's and Alabama's Coastal Zone Management Program and will be conducted in a manner consistent with such Program.

F. DISCHARGES AND EMISSIONS

The disposal of oil and gas operational wastes is managed by USEPA through regulations established under three Federal Acts. The Resource Conservation and Recovery Act (RCRA) provides a framework for the safe disposal of discarded materials, regulating the management of solid and hazardous wastes. The USEPA has exempted many oil and gas wastes from coverage under hazardous wastes regulations under Subtitle C of RCRA. If covered, such wastes would be more stringently regulated under hazardous waste rules, i.e., industry would be responsible for the wastes from their generation to their final disposal. Exempt wastes include those generally coming from an activity directly associated with the drilling, production, or processing of a hydrocarbon product. Nonexempt oil and gas wastes include those not unique to the oil and gas industry and used in the maintenance of equipment.

BEST AVAILABLE COPY

The direct disposal of operational wastes into offshore waters is limited by USEPA under the authority of the Clean Water Act. And, when injected underground, oil and gas operational wastes are regulated by USEPA's third program, the Underground Injection Control program.

An NPDES, based on effluent limitation guidelines, is required for direct disposal of operational wastes into offshore waters. The major discharges from offshore oil and gas exploration and production activities include produced water, drilling fluids and cuttings, ballast water, and storage displacement water. Minor discharges from the offshore oil and gas industry include drilling-waste chemicals, fracturing and acidifying fluids, and well completion and workover fluids; and from production operations, deck drainage, and miscellaneous well fluids (cement, BOP fluid); and other sanitary and domestic wastes, gas and oil processing wastes, and miscellaneous discharges.

All discharges associated with OEDC's proposed development operations will be regulated by the National Pollution Discharge Elimination System (NPDES). The EPA has not yet developed a proposed permit for the area east of the Mississippi River (Region IV).

When not allowed to be discharged at sea due to EPA restrictions, the waste will be transported on supply boats to the shore base in Dauphin Island, Alabama where it will be temporarily stored prior to disposal. All wastes will be manifested and records kept for the life of the field. In order to better manage the disposal of offshore waste, OEDC has developed a waste management plan that provides information to lease operators on regulatory requirements, source reduction, recycling and disposal. In general, oil field wastes are exempt from RCRA Subtitle C and disposal is regulated under each state's statutes. Nonhazardous industrial waste disposal is regulated under RCRA Subtitle D and again depends on state controls. Solid wastes will be taken to the service base, picked up by municipal landfill. Nonhazardous oil field wastes (NOW) will be taken to the service base and then to an approved NOW facility located in either Mississippi or Alabama. If any wastes are classified as hazardous, they are to be properly transported using a uniform hazardous waste manifest, documented, and disposed at an approved hazardous waste facility.

II. DESCRIPTION OF AFFECTED ENVIRONMENT

A. PHYSICAL ENVIRONMENT

1. Environmental Geology and Hazards

The proposed development activities are centered on the Mississippi, Alabama-West Florida panhandle (MAFLA) shelf approximately 20 nautical miles south-southeast of Mobile Point. The MAFLA shelf is that portion of the northeastern Gulf of Mexico between the Chandeleur Islands and DeSoto Canyon. The structure of the Gulf of Mexico continental margin is complex as a result of tectonic activity related to salt movement, reef growth, current activity, and the massive influx of sediment along its northern boundaries (Antoine, Martin, Pyle, and Bryant, 1974).

From Horn Island to Mobile Bay, St. Bernard prodelta sediments and sediments derived, respectively, from the ancestral Pascagoula River and Mobile Bay, have been deposited in sufficient amounts to produce a nearly flat, smooth sea floor. Eastward from Mobile Bay, the sea floor is rough and irregular due to the presence of relict topography which contains both sand waves and low relief swells that produce a very gently undulating surface comprising sediment hills with wave lengths of a few hundred to a few thousand feet, and amplitudes of approximately 3 to 36 feet. Where present, low-relief swells contrast with areas that have no undulations; significant trends are evident in plots of their predominant direction of asymmetry (direction of the steepest dipping face).

Sediments contain a mixture of biological and petroleum hydrocarbons. Biological hydrocarbons are predominantly plant biowaxes with a minor planktonic input possible. Petroleum hydrocarbons are present as polynuclear aromatic compounds (PAH), a complete suite of n-alkalines, and an unresolved complex mixture. Sediment PAHs on the shelf average six times lower than PAHs analyzed in sediments in adjacent bays.

Sediments on the Mississippi-Alabama shelf are very dynamic and change on time scales varying from less than six months to more than two years. Inputs are complex and often independently driven. Removal processes are complex, constituent-dependent and vary independently. Sediment properties vary by an order of magnitude or more. Many of these variations are directly

BEST AVAILABLE COPY

related to variations inland derived inputs that are mediated by river outflow from the Mississippi River Delta system as well as other rivers in the area. Hydrocarbon pollutant loading to sediments is primarily derived from fresh, unrefined petroleum closely associated with fine particulates derived from riverine transport. Aeolian transport and outflow from coastal bays appear to be minor influences.

2. *Air Quality*

Offshore air emissions related to the proposed production activities result mainly from construction operations and service vessels. These emissions occur mainly from combustion or burning of fuels and natural gas and from venting or evaporation of hydrocarbons. The combustion of fuels occurs primarily on diesel-powered generators, pump or motors and from lighter fuel motors. Other air emissions can result from catastrophic events such as oil spills or blowouts.

Primary air pollutants associated with OCS activities are nitrogen oxides, carbon monoxide, sulphur oxides, volatile organic compound, and suspended particulate.

The OSCLA (43 U.S.C. 1334(a)(8)) required the Secretary of the Interior to promulgate and administer regulations that comply with the National Ambient Air Quality Standards (NAAQS) pursuant to the Clean Air Act (42 U.S.C. 7401 et seq.) and to the extent that authorized activities significantly affect the air quality of any State. Under provisions of the Clean Air Act Amendments of 1990, U.S. Environmental Protection Agency's (USEPA) Administrator, in consultation with the Secretary of the Interior and the Commandant of the Coast Guard, will establish the requirements to control air pollution in OCS areas of the Gulf.

For sources located in areas under MMS jurisdiction regulations are promulgated by 30 CFR 250.44, 250.45, and 250.46 and are applicable to OEDC's proposed development operations.

Projected Air Quality Emissions which provide for completion of the existing wells, installation of the proposed caissons and lease term pipeline, and all activities associated with the production of the proposed wells are included in the Initial Development Operation Coordination Document. The total

BEST AVAILABLE COPY

emissions for the proposed activities fell well below the allowable exemption levels.

3. *Physical Oceanography*

Oceanographic conditions of the northeastern Gulf of Mexico's (NEGOM) shelf results from the interplay of regional meteorological processes, regional topography, influences from the Gulf's deepwater processes and river discharges.

Important meteorological processes influencing the regional oceanography are atmospheric pressure, air temperature, and winds. Even though all three variables vary diurnally and seasonally, only the seasonal variation will be considered in this description. Barometric pressure observations at two coastal stations near the western (Mobile, Alabama) and eastern (Cape San Blas, Florida) boundaries of the area of interest vary seasonally. Winter mean pressures are 1019.08 millibar (mb) at Mobile and 1019.15 mb at Cape San Blas; respective summer mean pressures are 1016.12 and 1016.95 mb. The annual mean barometric pressure is 1017.4 mb at Mobile and 1017.8 mb at Cape San Blas. A pressure gradient exists on average from west to east which should give rise to a east-to-west sea surface slope. Air temperatures have annual means of 19°C at Mobile and 20°C at Cape San Blas. The winter mean temperatures, seasonal low, are 12°C at Mobile and 14°C at Cape San Blas; summer mean temperatures, seasonal highs, are 25°C and 26°C respectively. It is important to remember that extreme temperatures and barometric pressures do occur that depart considerably from their mean values. (Florida A&M University, 1988).

Prevailing winds in this region are from a southerly direction in spring and summer. During fall and winter, wind direction is mostly from a northerly direction because of the influence of cold fronts. These fronts tend to come at one to three day intervals. After the frontal passage, winds return to the prevailing southerly direction. On average, the summer speeds are lower than the winter speeds. Because of the greater speed of the northerly winds, the resultant wind velocity factor is from the north. Significant deviations from this pattern occur during tropical and extra tropical storms (Wolfe et al., 1988).

Regional topography in this area is dominated by the DeSoto Canyon which

BEST AVAILABLE COPY

divides the area into western and eastern zones. The apex or head of this canyon coincides with the minimum width of the shelf. The western zone has its isobaths running in a northeast-southwest direction and a variable width. The eastern zone's isobaths run in a northwest-southeast direction and its width is more uniform. Along the coastline several bays discharge fresh or brackish water into the adjacent shelf. Even though their individual or combined discharge is many times smaller than the Mississippi River fresh water output, they have significant influence on their adjacent shelf.

Deepwater processes influencing the shelf circulation are Loop Current intrusions and associated mesoscale eddies. A recent study suggests three modes of Loop Current interaction with the shelf that depend on the intrusion's route. Loop Current eddies could affect the general circulation when they approach the slope and transfer momentum and water to the shelf. In that area, these interactions have occurrence frequencies of less than 5%.

The Mississippi River, the main contributor of fresh water to this area, contributes from 45% to 63% of its outflow to the region (Walker and Rouse 1993; Eleuterius and Criss 1994). Its influence can be found at the distances of up to 100 km east of the Delta in this shelf (Eleuterius and Criss 1994).

Hydrography

This section summarizes information about the basic hydrography parameters: sea water temperatures and salinity. Both are needed to calculate sea water density and serve as tracers of water masses and indicators of oceanic circulation. These observations also are important in other oceanographic fields. The discussion, by necessity, examines the surface fields of each parameter and their vertical distributions.

The circulation on the Louisiana-Mississippi-Alabama shelf (LMAS) and adjacent region has been characterized using historical hydrographic data and current meter data. Generalized seasonal circulation patterns have been proposed (Figure 1). These patterns are based on objective data over the inner shelf, outer shelf, and upper slope. The midshelf patterns are more subjective.

Westward flows on the inner shelf, outer shelf and upper slope in the spring and summer (Figure 1) are interpreted as the northern and southern portions

BEST AVAILABLE COPY

of closed cyclonic and anticyclonic circulation cells, respectively. Spring and summer midshelf flow is eastward. This is consistent with flow around two counter-rotating circulation cells. The offshore flow over the eastern LMAS shelf break has three possible fates. Some shelf water flows westward along the upper slope and may either recirculate around the anticyclonic cell, moving on shelf just east of the Mississippi Delta, or continue west across the Delta front. Some water moves offshore and then up the DeSoto Canyon, flowing onshore and then westward over the inner shelf. Finally, some may continue to flow southeastward along the eastern flank of the Canyon. A convergence on the western LMAS must occur between the onshore flow just east of the Delta and inner shelf moving south along the Chandeleur Islands. This water must then move eastward, across the LMAS toward the DeSoto Canyon and the region of shelf break exchange.

The observed mean inner shelf flow patterns are consistent with wind-driven flow. Mean monthly winds, for an 11-year period (1974-1984), were from an eastern quadrant during most of the year (Schroeder and Wiseman, 1985). The mean easterly winds during the fall can be assumed to drive an inner shelf circulation similar to that observed in the spring and summer. At the same time, flow from west of the Delta turns on to the shelf just east of the Delta (Figure 1). The principal pattern of two counter-rotating cells on the shelf with onshore flow to the west and offshore flow to the east remains.

The anticyclonic circulation over the outer shelf and upper slope is not present during the winter. Winter shelf circulation appears to consist of a single cyclonic cell. Currents are eastward over the upper slope and westward over the inner shelf (Figure 1). There is weak offshore flow all along the shelf break in winter.

Spring discharge from the Mississippi River disperses eastward along the shelf-break. A ridge of high dynamic topography results on the shallow isobaric surfaces. Circulation is clockwise around this ridge, eastward over the outer shelf and westward over the upper slope. Outer shelf and slope flow during summer and fall, is a continuation of that associated with spring runoff conditions. Most of the fresh water is gone from the outer shelf by winter. Weak offshore and eastward flow over the outer shelf and upper slope are consistent with the dynamic topography.

The inner shelf circulation is parabolic cyclonic flow interrupted by periodic

reversals associated with northwesterly winds. Peak current speeds observed during winter, spring and summer exceeded 0.3 m/s in either along-shore direction. Post-front wind direction and duration appeared to be related to the degree of spatial coherence in along-shore flow. Normal circulation relaxed as cold fronts moved through the region and wind directions shifted. Fast-moving fronts tended only to interrupt the existing flow, but longer periods of post-front winds from northwest reversed the inner shelf flow direction.

Wave-induced sediment resuspension and advection by subtidal bottom currents are both necessary for net sediment transport on the inner shelf. Long-term hindcast wave statistics were analyzed. Sediment resuspension during high wave conditions can occur in water depths of 40 m or less. Sediment transport occurs primarily during prefrontal winds conducive to long waves and cyclonic inner shelf flow in the winter and spring.

Winds during the summer are weaker. Locally generated wind waves would resuspend shelf sediment at shallower water depths. Outer shelf and upper slope sediments are most likely to be resuspended only by hurricane condition waves or, possibly, by direct influence of the Loop Current.

Continued investigation is needed to understand the inner shelf-outer shelf exchange and midshelf flow. Observed shelf-break exchange is not documented by in situ current measurements, nor are the time and spatial scales of outer-shelf variability understood.

Sea Surface Temperature

The sea surface temperature (SST) is important because of its significant role in air-sea interactions and for surface sea water density. Data summaries of monthly mean SST (Dyanalysis of Princeton, 1993; Florida A&M University, 1988; U.S. Navy, 1986; Robinson, 1973) show a seasonal variation of SST, a response to the seasonable change in solar of solar heating. The maximum monthly mean SST (28-31°C) occurs in July-August and the minimum monthly mean SST (15-22°C) in January-February. These temperature ranges represent values of SST from onshore to offshore. The lower values occur nearshore because of the shallower water depth. On the basis of these monthly SST averages, Florida A&M University (1988) identified two seasons; winter (December, January, February, and March) and summer (May, June, July, August, September, and October). April and November are

BEST AVAILABLE COPY

transitional months. The small SST range in summer is due to the low wind speed, reduced vertical mixing, and high solar heating. These conditions lead to an almost isothermal Gulf of Mexico's sea surface. An isothermal Gulf surface hampers the use of satellite or remote sensing techniques to identified surface features such as warm or Loop Current eddies. The large SST range in winter is due to the high wind speeds and ensuing mixing, low solar heating, and the increasing water depth in the offshore direction. In consequence, water near or beyond the shelf's edge does not cool much in winter because of the greater water depth and heat distribution over a greater water volume.

The standard deviation of the SST surface fields (Dynamics of Princeton 1993) confirms the above inferences about SST ranges in a generalized way. Greater values of temperature standard deviations occur in winter and early summer (1-2°C to 2-4°C) and are lowest in mid summer (< 0.8°C).

Aside the onshore-offshore SST gradient, the available data suggest an alongshore SST gradient in this region. The Florida A&M University (1988) mean SST monthly fields show a bending of isotherms toward the Cape San Blas area. Kelly (1991) and Nolinari et al. (1979) noticed that isotherms in this region tend to be parallel to the isobaths. The resulting west to east SST variation between Mobile, Alabama and Cape St. George, Florida, reaches values of 2°C and the SST increases eastward. This gradient seems to exist in winter. The U.S. Navy (1986) SST fields also show a similar temperature variation, but only in the winter months of November and December. The SST fields of Dynamics of Princeton (1993) display a much smaller gradient (0.2°C) but only in May. Because of the nearly isothermal temperature field in summer, there are no temperature variations in any direction.

Besides the regional and seasonal SST gradients, larger and steeper SST gradients, called "fronts," exist. Vukovich and Hamilton (1990) studied three types of fronts in the Gulf of Mexico: Loop Current, warm eddy, and shelf fronts. Their results indicate a frequency of 25-35% of finding a shelf front along the 200 m isobath and less than 5% for warm eddies and Loop Current fronts in the area of interest. None of the three front types studied by Vukovich and Hamilton (1990) are found over the shelf.

Vertical Temperature

Data on vertical temperature profiles provide a consistent seasonal pattern of temperature variation. Because of the small temperature data base, it is impossible to provide statistical measures (mean and variances) for these vertical profiles. It is important to keep in mind that water temperature increases offshore during winter because of the large thermal inertia of water and increasing water depth. In winter, the water column is nearly isothermal in nearshore areas with temperatures around 20-25°C and slightly warmer temperatures (1-3°C warmer) near the bottom. During spring and summer, the vertical profile of temperature indicates a two layer system or stratified water column. The surface layer reaches temperatures of 26-30°C and decreases by about 4°C in early summer and by 8°C in late summer when reaching 199 m water depths (Kelly, 1991; Molinari et al., 1979; Churgin and Halminski, 1974). Deviations from this pattern occur and are generally associated with Loop Current intrusions or fresh water advection (Kelly, 1991, Molinari et al., 1979).

Surface Salinity

Maps of monthly means surface salinity for the entire Gulf of Mexico have been prepared by Dynalysis of Princeton (1993). The salinity field in this area is the result of a mixture of Mississippi River water, low salinity water from the adjacent sounds and bays, and high salinity water from the deep Gulf of Mexico (Barry A. Vittor and Associates, 1985). The monthly mean surface salinity plots show that salinity in this region is mostly oceanic with value ranging from 33 to 36 ppt. A seasonal cycle which is opposite that of the SST is evident. Maximum salinity occurs in winter, reflecting the low fresh water input from the rivers and bays along the coastline. It is noteworthy to notice that this trend is contrary to open oceanic conditions where surface salinity and temperature are in phase. The minimum salinity occurs in midsummer. These plots and other available data (Eleuterius and Criss, 1994; Kelly, 1991; Churgin and Halminski, 1974) show an eastward increase of surface salinity. This gradient reflects the location and advection of fresh water inputs. The surface salinity gradient appears to vary seasonally; from November to February, it is directed from west to east; from February to May, it rotates anticyclonically; and becomes directed completely offshore in May to September. The cycle is completed with a cyclonic rotation during September to November and the re-establishment of the west-

BEST AVAILABLE COPY

east gradient.

The standard deviation of the monthly means (Dynamics of Princeton, 1993) is greater during winter (0.8 to 1.2 ppt) and smaller in summer (0.6 and 0.8 ppt). It is important to notice that larger variations of salinities occur. For example, in Eleuterius and Criss (1994), salinity values as low as 26 ppt over the shelf associated with advection of fresh water from the Mississippi River through the area.

Vertical Salinity

Vertical salinity distributions indicate that seasonal salinity variations decrease with the depth over the shelf. Most of the vertical profiles examined over the shelf indicate salinity values of over 36 ppt (range of 36.6 to 36.5 ppt) in the deeper layers (Kelly, 1991; Churgin and Halminiski, 1974). The monthly means salinity plots at 100 m water depth show salinity values consistently between 36.3 and 36.45 ppt (Dynamics of Princeton, 1993).

Hydrography Variations at Time Scales of days

Temperature and salinity variations at time scales of days are well documented in cruises, for example see the reports of Eleuterius and Criss (1994) and Kelly (1991). In their summary of data collected from 1963-1965, Eleuterius and Criss (1994) present evidence of the Mississippi River outflow transported in a northeast direction bringing lenses or parcels of fresh water, and how saltier, warmer water enters the shelf through DeSoto Canyon. They estimate the influence of Mississippi River water to about 100 km east of the Delta. Kelly (1991) discusses data from four cruises conducted from 1987 to 1989. The first cruise (February-March 1987) is an example of low salinity water influence from Mobile Bay. The cruise data of September-October 1987 shows warm, saltier water entering the shelf from the Southeast. The bottom waters are more saltier suggesting a transport of water westward and derived from a Loop Current intrusion. Data from the August 1988 cruise show an example of meteorological water conditioning. Saltier water on the shelf coupled with lower temperature is attributed as being formed locally by evaporation during drought conditions of that year.

BEST AVAILABLE COPY

Tidal Regime

The astronomical tide in the Gulf of Mexico can be characterized by a small amplitude and different behavior of the tidal components (Red, 1988). The dominant tidal components in the Gulf of Mexico are the diurnal, luni-solar (K1), and principal lunar (O1) acting as Hemholtz modes, and the semidiurnal, principal lunar (M2) (Reid, 1988). The period of these components are $T_{K1}=23.934$ hrs; $T_{O1}=25.819$ hrs, and $T_{M2}=12.421$ hrs.

The character or type of tide for a region is determined by the form number (F). In this region, $F \geq 3$ from Mobile, Alabama, to about Shell Island, Florida, indicate a diurnally tide regime. Between Shell Island and Apalachicola Bay, $1.5 \leq F < 3$ values indicate a semidiurnal tide regime.

The amplitude of the two diurnal components is almost uniform over the entire GOM, and in the area of interest varies from 17 to 14 cm (Reid, 1988). The amplitude of the semidiurnal M2 tide is 3 cm from Mobile to Shell Island and about 32 cm near Apalachicola Bay. Based on these values, the tide's amplitude between Mobile and Shell Island could be about 37 cm, and about 68 cm from Shell Island to Apalachicola Bay. The observed tidal range of the diurnal tide is 37 to 52 cm, and 67 to 116 cm for the semidiurnal tide.

Sea levels along the GOM also exhibit a seasonal cycle. A time series of sea levels spanning 57 years (1923 - 1980) at Pensacola, Florida, shows a minimum sea level in January with a monotonic increase that peaks in September. The total sea level variation is about 24 cm (Hicks et al., 1983). A shorter sea level time series (22 years) displays a bimodal distribution variation of 8-9 cm. The minima occur in January and July. Two unequal maxima occur, a lower one in April and the higher one in September.

Another type of sea level change is caused by meteorological forces, which in the area of interest could be equal to or greater than the astronomical tides.

A much larger and pragmatically important sea level change, is the storm surge. The storm surge depends on the shelf topography, storm wind speed, and forward velocity. For the area of interest, about 2.3 storms can land every 100 years across a 10 nautical mile coastal segment (Joyce, 1992). Of these two storms, one could be a hurricane (EM 1110-2-1412, 1986). For this region, the nominal storm surge is about 0.9 cm with a range of 0.6 to 1.6

BEST AVAILABLE COPY

cm above the astronomical tide for the 100-year hurricane (Coats, 1992). However, an analysis of storm surges for Texas to Florida, indicates that storm surges of about 4 m are possible during the 100-year flood (Kelly et al, 1984). In the Mississippi Sound, a storm surge of 1.5 m was measured (Barry A. Vittor & Associates 1985).

Information on tidal currents for the area of interest is scarce, but the available information indicates values of 15 cm/s (Clarke, 1994). Applying linear wave theory in this shelf-yield estimates of 15 cm/s at water depths of 100 m and 22 cm/s in waters 50 m deep.

Sea State

The GOM's wave climate is characterized as being generated inside the Gulf and with hurricanes as significant sources of wave energy (Aubrey and Fields, 1992). Because of the generation areas and the shallow water effects there is a significant offshore-onshore wave energy. Wave measurements from NBC buoys in the eastern GOM reveal that offshore mean wave height (~1.2 m) is higher than the nearshore mean wave height (~1 m); this trend also holds for the maximum wave height; ~6 m offshore verses ~0.5 m nearshore. Aside from this onshore-offshore gradient, the wave height also varies seasonally. At the offshore station, the highest mean wave high (~1.6 m) occurs in winter; spring and fall have identical mean wave height of ~1.4 m; and lowest in summer (~0.9 m). At nearshore stations, the seasonal cycle is similar to the winter mean wave height of ~1.4 m, ~1.3 m in spring, ~1.1 m in fall, and ~0.8 m in summer. The maximum wave height also displays a similar seasonal variation, highest in winter (>8m); lowest in summer (~1.8m); with spring and fall wave heights about equal (~4 m). The offshore-onshore gradient is also evident in the U.S. Navy (1986) data summary. The most frequent (57%) wave height nearshore areas are those of less than 0.6 m, followed by waves of 0.9-1.5 m (30%) and about equal frequencies (7-9%) for waves of 1.5-1.8 m and 2.1 -2.7 m. At offshore areas the frequency for wave heights of 0.9 m decreases to 48%, the waves of 0.9-1.5 m remain about equal, but the higher waves almost doubled in their occurrence frequency. Waves of 1.5-1.8 m have frequency of 13% and waves of 2.1-2.7 m increases to 9%.

A wave hindcast for the entire GOM shows that in this area the average significant wave height is about 1 m with a period of 5 seconds and most

BEST AVAILABLE COPY

frequent direction between 135-157.5° (Hubertz and Brooks 1989). The largest hindcast waves are near 4.7 to 2.7 m and periods of 11 to 8.3 seconds. These larger waves are associated with directions varying from 138° to 210°. The wave height and period associated with the 100-year storm in this region are: maximum wave height 18-24 m, wave period is 11-15 seconds (Coats, 1992). Recent measurements of waves associated with Hurricane Andrew in the Gulf of Mexico revealed that the wave period could be as high as 16 seconds and another significant wave at the first harmonic caused by nonlinear dynamics (DiMarco et al., in press).

Regional Circulation

The main driving forces of the NEGOM regional circulation are winds, Loop Current, and related filament intrusions, and fresh water input from the Mississippi River and adjacent bays and estuaries. Kelly (1991) provides the most complete analysis of currents, sea levels, and wind stress for this shelf region. Over most shelf locations he found high coherence between winds and currents in the frequency range of 0.08 to 0.20 cycles per day (cpd) or periods of 5 to 13 days. At the inner shelf, the observations indicate simple Ekman response of the entire water column. At mid- and outer-shelf stations, the response is more likely a wind-forced wave with a similar frequency range. Over the slope, there is little coherence between currents and winds, and when high coherence exists, it occurs at specific frequencies. Based on the phase angles, a free and forced response seems to prevail in this region. The correlation between sea levels at Dauphin Island and wind stress was also high over a broad range of frequencies. In winter/spring the sea level responded to both the along- and cross-shelf wind stress components; in summer the sea level response was to along-shore stress only. The relationship between sea level and wind stress was studied more quantitatively by Marmorino (1982). He found a high correlation in a frequency range similar to Kelly (1991). Further, he estimated that at Apalachicola and Pensacola, the sea level increases about 26-31 cm for a wind stress of 1 dyne/cm² in the alongshore direction. Loop Current effects on the shelf occur mainly through intrusions which tend to modulate the wind driven flow. Kelly (1991) found three modes of Loop Current interactions: a direct intrusion along DeSoto Canyon, an intrusion of shelf water into one of the Loop Current filaments, and a direct intrusion of the Loop across the entire GOM and onto the shelf. Sea water density in this region is controlled essentially by salinity, which in turn is controlled by the fresh water input

BEST AVAILABLE COPY

BEST AVAILABLE COPY

(Dinner, 1988). Thus, fresh water inflow into the shelf contributes to the dynamic height anomalies calculated over this region by Dinnel (1988) and drives the geostrophic currents.

Mean seasonal surface currents derived from ship drift data for this region are presented, for example, in one by one degrees squares (U.S. Navy, 1986). Surface circulation based on these estimates indicates a westerly flow in the inner shelf area with speeds close to 50 cm/s throughout the year. In the outer shelf/upper slope region, the flow is mostly southwestward near the Mississippi River Delta in winter, summer, and autumn; in spring the flow is northerly. Near Cape San Blas, currents are mostly northerly in spring, summer, and autumn; in winter, the flow is southeasterly. The speed at the outer shelf is around 30 cm/s year round. Based on measurements and geopotential anomaly maps, Dinnel (1988) proposed a shelf circulation consisting of two cells across the shelf in spring, summer, and fall. The inner shelf cell is cyclonic and the outer shelf shell is anticyclonic. Both cells meet at the mid shelf where the flow is directed eastward. In winter, the outer shelf cell breaks down and only the inner shelf cyclonic cell persists. Also, onshore flow tends to accompany the summer regime circulation near flow tends to accompany the summer regime circulation near the DeSoto Canyon, but offshore during spring and fall. In winter this flow is along the isobaths and directed northeast. Based on current measurements over the outer shelf, Kelly (1991) found no evidence for the outer shelf anticyclonic circulation. However, he found evidence for the inner shelf anticyclonic cell.

Combining the wind-driven circulation and the modulation effects of the Loop Current intrusions, Kelly (1991) proposed a tentative scheme for the mean shelf circulation consisting of a single cyclonic cell over the entire shelf extending to the outer shelf and slope. Eleuterius and Criss (1994) also proposed a similar anticyclonic cell over the entire shelf but with no seasonal variations. They based this conclusion on salinity data collected between 1963 and 1965. It is important to notice that either Dinnel's or the Kelly-Eleuterius-Criss' circulation scheme needs to be verified with field observations.

4. *Water Quality*

Water quality in the NEGOM area may be negatively affected by the migration of degraded coastal water quality conditions, by offshore

BEST AVAILABLE COPY

discharges from shipping operations, by Mississippi River intrusions, and by changes in turbidity resulting in high suspended solids and poor water clarity due to storm surges.

Coastal water quality in this area is affected by both industrial and municipal discharges and runoff. Compared to areas east and west of the Mississippi Sound, this area is still relatively unpolluted.

The greatest amount of industrial growth has occurred in Pascagoula River, Escatawpa River, and Bayou Casotte (Rabelais, 1992). Hydrocarbons were the most significant contaminants found in Mississippi Sound sediments. This was likely associated with the oil refinery and oil industrial complex. The pollutants found near the heavily industrialized areas of the rivers have not migrated out into the Sound. Low dissolved oxygen has been infrequently measured in the area during the warmer months. Blooms or red tides have occurred several times in the last 20 years in the Sound, sometimes resulting in fish kills. The Bayou Cassotte area has the greatest industrial contamination. A ship channel and harbor with industrial activities that include petroleum fuels; petrochemicals; metal processing and fabricating; and nitrogen, potassium, and phosphorus fertilizers characterize the area.

The estuarine and inner shelf areas of the Central Gulf are strongly influenced by freshwater flow from a number of major drainage systems, especially the Mississippi River and the Mobile-Tombigbee-Alabama river system. A complex geography of shallow sounds and bays and extensive tidal marshes protected by a chain of barrier islands acts to delay mixing, resulting in extensive areas of mesohaline conditions. Turbidity values are normally quite high, with suspended particles primarily composed of clay minerals (Hedges and Parker, 1976).

Mississippi Sound, adjacent to the coast of Mississippi, is subject to rapid changes in both temperature and salinity because of atmospheric variations, river discharges, rainfall, and tides. Within this estuarine system, significant stratification or water column inversions may occur at various times during the year. A salt wedge is detectable in all of the rivers in late summer and fall (Christmas and Eleuterius, 1973).

The Mississippi River input creates a lens of fresher, more turbid water. The most important characteristic of this fresh lens is its stratifying effect on the

water column of nearshore waters. Hypoxic bottom-water conditions are frequently observed during summer months, particularly August, on the central Louisiana shelf. Mass mortality of organism and characteristic chemical changes also occur. Although the Mississippi and Alabama inner shelf has the potential for bottom water-hypoxia, and low oxygen concentrations have been documented, such events are not considered frequent nor widespread as is the case off Louisiana (Rabelais, 1992).

B. BIOLOGICAL ENVIRONMENT

1. Coastal Habitat

The coastal and continental shelf waters of the Tuscaloosa Trend study are comprise a highly productive ecosystem. This area of the northern coast is bounded by Mobile Bay and Mississippi Sound on the north and the Mississippi River Delta on the west. In addition to these mainland shoreline features, the barrier islands adjacent to the Mississippi Sound and Chandeleur Sound further serve to increase the land-sea interface. The ratio of shoreline to open water has been shown to have a direct effect on overall productivity of ecosystem (Turner, 1982). High productivity is attributable in part to the extensive coastal marshes associated with these shoreline features, which contribute energy to the system through conversion of sunlight into plant material. Terrigenous nutrients delivered to the coastal zone via numerous rivers also contribute to high rates of primary production. The nutrient value of this plant material is further enhanced upon decomposition by serving as a substrate for bacteria and other microorganisms. This enriched, decomposed plant material (or detritus) forms the basis of a complex food chain in coastal and adjoining outer continental shelf (OCS) waters.

The communication and exchange of water between the OCS and estuarine area illustrates the important and dynamic relationship occurring within this ecosystem. During monthly tidal cycles, water and entire planktonic communities may be transported through tidal passes into or out of the estuary (depending upon season and relative abundance). Many species which live on the bottom as adults are recruited into the estuaries as planktonic larvae. Nektonic organism may pass in and out of the estuaries without tidal assistance.

BEST AVAILABLE COPY

some seagrass dieback for one growing season. No permanent loss of seagrass habitat would result from the spill.

2. *Effects on Offshore Habitats*

The sessile and pelagic communities associated with the crest and flanks of the pinnacle and hard-bottom features would be adversely impacted by oil and gas activities if such activities took place on or near these communities without the Live Bottom (Pinnacle Trend) Stipulation. This stipulation does not prevent the recovery of oil and gas resources, but it does serve to protect valuable and sensitive biological resources. Live Bottom Stipulations have been made a part of the lease on blocks on or near these biotic communities so that impacts from nearby oil and gas activities were mitigated to the greatest extent possible. The proposed operations are not located within the area deemed by the Minerals Management Service as an area of high probability for live bottom communities.

Damage caused by oil spills, blowouts, anchoring, structure emplacement and removal, drilling discharges, and pipeline emplacement can cause adverse affects to the pinnacle trend communities and features.

Produced water usually contains high amounts of dissolved solids and total organic carbon, and low amounts of dissolved oxygen. Other common components include heavy metals, elemental sulfur and sulfide, organic acids, treating chemicals, and emulsified and particulate crude oil constituents. Salinity can vary from a few parts per thousand (ppt) to 300 ppt. The constituents of produced water have the potential to adversely impact the livebottom organisms of the pinnacle trend if the constituents reach them in high enough concentrations. Domestic and sanitary wastes originate from sinks, showers, laundries, and galleys, as well as waste water from safety showers, eye-wash stations, and fish-cleaning stations. Human wastes, which contain fecal coliform bacteria, are treated by approved marine sanitation devices prior to discharge. Rapid dilution and dispersion of these wastes would occur upon discharge.

Pipeline emplacement directly affects the benthic communities through burial and disruption of the benthos, and through resuspension of sediments. These resuspended sediments may clog filter-feeding mechanisms and gills of fishes and sedentary invertebrates.

BEST AVAILABLE COPY

The term "barrier" identifies the structure as one that protects other features, such as bays, lagoons, estuaries, and marshes, from the direct impacts of open ocean. By separating coastal waters from the ocean, barriers contribute to the amount of estuaries habitat available along the coast. As much as two-thirds of the high-value Atlantic and Gulf species of fish are considered to be directly dependent during some stage of their life on conditions in an estuary.

Another benefit of both the barriers and their adjacent marshes and bays is that of providing habitats for a large number of birds and other animals, including several threatened or endangered species, such as the loggerhead turtle, the southern bald eagle, the alligator, and the brown pelican.

Barrier land forms are relatively low landmasses that are continually adjusting configuration in response to changing environmental conditions. Landform changes can be seasonal and cyclical, such as the transition from a summer (swell wave) beach to a winter (storm wave) beach, or they can be indicative of a trend, such as a net landward movement of a feature. The long-term survival of fixed structures, such as roads, buildings, and power lines, constructed on a barrier landform can often be jeopardized by the changing and migratory nature of the barrier features. Some types of construction or stabilization projects on barrier land forms may actually encourage erosion, especially when the project interferes with long shore or shore-normal sediment movements.

The barrier land forms of the Central Gulf of Mexico occur in three settings. From east to west, these include the barrier islands of Mississippi Sound, the Mississippi River deltaic plain barriers, and the barriers of the Chenier Plain in Louisiana.

Coastal Marshes

Coastal Marshes which fringe the mainland in the northern GOM are typically low energy, highly productive ecosystems. They contribute large amounts of organic material to surrounding waters and serve as sediment traps for suspended particulates of terrestrial origin. Marshes act as a buffer zone between marine and terrestrial environments and provide a habitat for many animal species during critical periods of their life cycle. Marsh plant communities occupy defined zones and types, characterized especially by salinity and tidal amplitude. Other physical factors which determine species

zonation within the marsh include frequency and duration of tidal flooding, elevation of the marsh soils, and degree and duration of freshwater flooding.

Coastal Wetlands

In Mississippi and Alabama, the mainland marshes behind Mississippi Sound occur as discontinuous wetlands associated with estuarine environments. The most extensive wetland areas in Mississippi occur east of the Pearl River delta near the western border of the State and in the Pascagoula River delta area near the eastern border of the State. The wetlands of Mississippi seem to be more stable than those in Louisiana, reflecting the more stable substrate and more active sedimentation per unit of wetland area. Also, there have been only minor amounts of canal dredging in the Mississippi wetlands.

Most of the wetlands in Alabama occur on the Mobile River delta or along northern Mississippi Sound. Between 1955 and 1979, fresh marshes and estuarine marshes declined in these areas by 69% and 29%, respectively. On a percentage basis, wetlands loss has occurred more rapidly in Alabama during these years than it did in Louisiana. Major causes of non-fresh wetland losses were industrial development and navigation, residential and commercial development, natural succession, and erosion/subsidence. The loss of fresh marsh was mainly attributable to commercial and residential development and silviculture.

Coastal barrier land forms consist of islands, spits, and beaches that stretch in an irregular chain from Alabama to Texas. These elongated, narrow land forms are composed of sand and other unconsolidated, predominantly coarse sediments that have been transported and deposited by waves, currents, storm surges, and winds. Barrier land forms are young coastal features. They began to form 5,000 to 6,000 years ago after the main mass of continental ice sheets had melted and global rate of sea-level rise began to slow.

Seagrasses

Offshore seagrasses are not conspicuous in the GOM; however, fairly extensive beds may be found in estuarine areas behind the barrier islands throughout the Gulf. Seagrasses would be continuous around the entire periphery of the Gulf if it were not for the adverse effects of turbidity and low salinity of the Mississippi effluent. In general, the vast majority of the

BEST AVAILABLE COPY

benthos of the Gulf consists of soft, muddy bottom dominated by polychaetes. The most extensive beds occur in Chandeleur Sound in coastal Louisiana and the Mississippi Sound. The distribution of seagrass beds in the Gulf have diminished during recent decades. The primary factors believed to be responsible for these conditions include hurricanes, freshwater diversions from the Mississippi river during flood stage into coastal areas dredging activities and water quality degradation.

2. *Offshore Habitat*

The term sensitive offshore resources refers both to the water column and the sea floor. Sea floor (benthic) habitats are the most likely to be adversely affected by offshore oil and gas operations, especially live-bottom areas, deepwater benthic communities, and topographic features. The northeastern portion of the Central Gulf of Mexico exhibits a region of topographic relief, the "pinnacle trend," between 67 and 110 m (220 and 360 ft) depth. The pinnacles appear to be carbonate reefal structures in an intermediate stage between growth and fossilization. The region contains a variety of features from low to major pinnacles, as well as ridges, scarps, and relict patch reefs. It has been postulated that these features were built during lower stands of the sea during the rise in sea level following the most recent ice age. The heavily indurated pinnacles provide a surprising amount of surface area for the growth of sessile invertebrates and attract large numbers of fish.

The pinnacles are found at the outer edge of the Mississippi-Alabama shelf between the Mississippi River and DeSoto Canyon. The bases of the pinnacles rise from the sea floor between 50 and 100 m with vertical relief occasionally in excess of 20 m. These features exist in turbid water and contain limited biotal coverage. Pinnacles photographed in 1985 showed biota similar to the transitional antipatharian-zone assemblage described by Rezak (CSA, 1985). These pinnacles may provide structural habitat for pelagic fish.

With the exception of the region defined as the pinnacle-trend areas, the substrate in waters shallower than 67 m of the Central Gulf is a mixture of mud and/or sand. The live-bottom survey required by MMS and conducted in the eastern portions of the area have also revealed sand or mud substrate. These areas are not conducive to "live-bottom" community growth since a hard substrate is needed for epifaunal attachment. As the substrate grades to

BEST AVAILABLE COPY

carbonate sand in the Eastern Gulf, the potential for "live bottoms" increases.

In sand bottom areas which support an epibiotal community, coarse rubble consisting of coralline algae, mollusc shell fragments, calcareous polychaete tubes and unattached biota, various sponges, soft corals, and bryozoans frequently accumulate in depressions and sand wave troughs. In addition, other frequently observed epibiota in sand bottom areas include red algae, crustaceans, asteroids, echinoids, and holothuroids. The photo documentation report also lists macroinfaunal sampling results from two sand bottom stations sampled by CSA in 1992 and compares them to the Mississippi-Alabama Marine Ecosystems Study (Harper, 1991). The two samples were sampled in sand and silty sand areas, and differed mainly with respect to individual abundance, diversity and richness were high at both stations, while individual abundances (density) were low to moderate. Both assemblages include a high abundance of surface and burrowing deposit feeders, and were consistent with species groups described by Barry A Vittor & Associates, Inc., in the Tuscaloosa Trend Regional Data Search and Synthesis Report.

As stated in site specific geophysical survey reports prepared for each of the subject Blocks, the sea floor sediments are reported to be sands. Sonar records indicate variability in the surficial soils. The surficial sediments are reported to be sands of the Mississippi-Alabama sand facies of the Mississippi Alabama-West Florida panhandle (MAFLA) sand deposit (USDOI, MMS, 1983: Visual No. 3). The model mixture for this facies is 93% terrigenous sand, 7% carbonate sand (calcareous), and 0% silt and clay (Ludwick, 1964). Kyanite and staurolite dominate the heavy mineral assemblage. The increase in reflectivity probably indicates increase in grain size, possibly due to shell and shell hash.

3. *Endangered, Threatened and/or Protected Species*

Sea Turtles

Five species of sea turtles may be found in the NEGOM. The Kemp's Ripley (*Lepidochelys kempii*), leatherback turtle (*Dermochelys kempii*), and hawksbill turtle (*Eretmochelys imbricata*) are federally listed as endangered in both Florida and Alabama. The loggerhead turtle (*Caretta caretta*) is listed as threatened there, and the green turtle (*Chelonia mydas*) is

BEST AVAILABLE COPY

endangered in Florida but threatened in Alabama. The leatherback turtle, green turtle, and loggerhead nest in Florida. Surveys in May-July showed that most sea turtles nesting in west Florida and Alabama were loggerheads and that numbers of nesting females of this species were low there compared to numbers on the southeast United States Atlantic Coast (Shoop et al., 1985). The loggerhead may mate in waters offshore from nesting beaches (Nelson, 1988). Turtles may use smell and vision to find mates.

They use these senses to find food. Sea turtles intercoastal and estuarine waters where good vision may be necessary to find food in turbid conditions. Total suspended solids may exceed 60 mg/l in estuaries and 200 mg/l in rivers feeding estuaries (Ward and Armstrong, 1992). Loggerhead turtles feed on benthic invertebrates (Nelson, 1988). Leatherback turtles eat jellyfish and other transparent soft-bodied foods (Eisenberg and Frazier, 1983). Green turtles feed mostly on marine algae and on seagrasses, but jellyfish and other invertebrates are also taken (USDOI, FWS, 1980a); the invertebrates may be incidentally captured with plant food. Hawksbill turtles feed on hard- and soft-bodied invertebrates, including jellyfish (USDOI, FWS, 1980b). Kemp's Ripley turtles feed on fish and on hard and soft invertebrates (including jellyfish) (Pritchard and Marquez-M, 1973).

Birds

The piping plover (*Charadrius melodus*) is threatened in both Alabama and Florida. Breeding grounds are north of South Carolina. Young and adults depart for wintering grounds including the Gulf Coast shoreline by early September. Food items are invertebrates plucked from wet beach sand. The most important management is on the nesting grounds, where loss of sandy beaches has caused population decline. Destruction, modification, and disturbance of nesting habitat continues (USDOI, FWS, 1988).

The following account is taken from Gore and Chase (1989). The southeastern snowy plover (*Charadrius alexandrius tenuirostris*) is listed as threatened in both Alabama and Florida. The species nests on coastal sand beaches and interior alkali flats. Observed nest sites in the Florida panhandle ranged from the Florida-Alabama border eastward beyond Little St. George. At some locations more than 1.5 breeding pairs per kilometer were counted. Most nests are near the front dune and close to vegetation. Vehicles and humans may cause nest failure. Human activity is absent near the beaches of

BEST AVAILABLE COPY

Eglin Air Force Base aircraft. This may account for a high nest count in part of this area.

The Roseate tern (*Sterna dougalli*) is listed as threatened in both Alabama and Florida. However, in the panhandle region it has only been sighted five times and is a transient (USDOJ, FWS, 1995).

For the least tern (*Sterna antillarum*) only the population of interior nesting colonies is endangered.

Beach Mice

These mice are subspecies of the old field mouse (*Peromyscus polionotus*) that occupy the lee side of mature coastal dunes of Florida and Alabama. The Alabama, Choctawhatchee, and Perdido Key subspecies are listed as endangered (the Alabama subspecies in Alabama, the Perdido Key subspecies in both Alabama and Florida, and the Choctawhatchee subspecies in Florida). The range of these subspecies is listed in USDOJ, MMS (1994). The St. Andrew subspecies and Santa Rosa subspecies are candidates for listing in Florida. Beach mouse diet, habits, and reasons for population decline are given in USDOJ, MMS (1994).

Large Whales

Five baleen whales and one toothed whale are listed as endangered in the Gulf of Mexico. Of these, only the humpback "whale comes into water at continental shelf depths. Off the panhandle the only two humpback whale sightings were at water depths greater than 200 m (656 ft) on the continental slope (Jefferson et al., 1992). Sightings in the Gulf have been sporadic (USDOJ, MMS, 1994, and USDOC, NMFS, 1991).

Other Marine Mammals

Marine mammals are protected by the Marine Mammal Protection Act. Bottlenose dolphins are the most common delphinia in the nearshore waters of the continental shelf, and outer edge of the shelf (Mullin et al., 1991). There appear to be two ecotypes of bottlenose dolphins, a coastal form and an offshore form (Mead and Potter, 1990). However, at present, there is no evidence to support the assumption that inshore/offshore populations are

genetically discrete. The Atlantic spotted dolphin is the only species, other than the bottlenose dolphin, that commonly occurs over the continental shelf (Mullin et al., 1991, 1994; Davis et al., 1995).

4. *Non-Endangered Birds*

The offshore waters, coastal beaches, and contiguous wetlands of the northern Gulf of Mexico are populated by both resident and migratory species of coastal and marine birds.

They are herein separated into five major groups: seabirds, shorebirds, wading birds, marsh birds, and waterfowl. Many species are strongly pelagic, and therefore rarely seen from shore. The remaining species, which are most susceptible to potential deleterious effects resulting from OCS-related activities are found within coastal and inshore habitats (Clapp et al., 1982).

Seabirds are defined as those species that spend extended periods away from land and obtain all or most of their food from the sea while flying, swimming or diving (Nettleship, 1977). Some are coastal feeders and residents, whereas others remain offshore, foraging over deep water in pelagic regions (Nettleship, 1991). Within the GOM, the group comprises four taxonomic orders: Gaviliformes (loons), Podicipediformes (grebes), Procellariiformes (albatrosses, fulmars, petrels, shearwaters, and storm-petrels), Pelicaniformes (pelicans, tropic birds, boobies and gannets, cormorants, and frigate birds), and Charadriiformes (phalaropes, gulls, terns, noddies, and skimmers) (Clapp et al., 1982; Harrison, 1983). Evolutionary histories of all these species have been principally marine (Fisher and Lockley, 1954; Lack 1968; Nelson, 1979). Many species migrate and are found within the Gulf region only seasonally. Others display more localized dispersal and nomadic types of geographic movement in order to exploit food resources, which are patch in distribution (Nelson, 1979). Seabirds, which nest along the Gulf Coast, typically aggregate into social assemblies, or colonies, with the degree of coloniality varying between species (Parnell et al., 1988).

Shorebirds are a heterogeneous group belonging to the taxonomic order Charadriiformes. They rank among the world's greatest long-distance migrants, with species that seasonally traverse from the high Arctic to South America, to those that actually spill over into both Asia and the Old World

BEST AVAILABLE COPY

BEST AVAILABLE COPY

(Pitelka, 1979). Within the GOM, shorebirds comprise five taxonomic families--Jacanidae (jacanas), Haematop Oodidae (oystercatchers), Recurvirostridae (stilts and avocets), Charadriidae (plovers), and Scolopadidae (sandpipers, snipes, and allies) Hayman et al., 1986). Few of the species nest in the Gulf area. Most species are only wintering residents and/or "staging" transients. Many coastal habitats along the GOM are critical for the survival of these birds, providing essential wintering grounds and staging areas where migrating shorebirds ready themselves physiologically (increasing body mass up to 100%) for migrational leaps and possibly to gain energy reserves for reproduction (Terborgh, 1989; Pitelka, 1979; Helmers and Castro, 1991). Suitability of habitat is coupled with the fact that shorebirds exhibit a high degree of site-fidelity, returning to their wintering and/or nesting sites year after year (Hayman et al., 1986).

Marsh birds are omnivorous coastal and inshore species belongs to the taxonomic order Gruiformes, containing the families Gruidae (cranes) and Rallidae (rails, moorhens, gallinules, and coots). Cranes are long-legged and long-necked birds that resemble large herons.

The two North American species are the whooping crane (refer to description under Endangered and Threatened Species) and sandhill crane. They inhabit prairies, field, and marshes. Members of the Rallidae family are compact birds of cryptical habits. Gallinules, moorhens, and coots swim and are commonly found within ponds, lakes, marshes, and bays. True rails are highly elusive and rarely seen within the low vegetation of fresh and saline marshes, swamps, and rice fields (Bent, 1926; National Geographic Society, 1983; Ripley and Beehler, 1985).

Wading birds are conspicuous coastal and inshore species belonging to the taxonomic order Ciconiiformes, which contains the families Ardeidae (herons and egrets), Ciconiidea (storks), and Threskiornithidae (ibises and spoonbills) (Parkes, 1978). As a group they exhibit diverse foraging adaptations and strategies, and they are well distributed throughout the warmer regions of the globe. Most species nest in discrete colonies and many are virtually solitary outside of the nesting season (Mock, 1978).

Water fowl belong to the taxonomic order Anseriformes and include swans, geese and ducks. A total of 36 species are regularly reported along the north central and western Gulf coast, consisting of 1 swan, 5 geese, 11 surface

feeding (dabbling) ducks and teal, 5 diving ducks (pochards) and 14 others (including the wood duck, whistling ducks, sea ducks, the ruddy duck, and mergansers) (Clapp et al., 1982; National Geographic Society, 1983; Madge and Burn, 1988). A diverse array of adaptations associated with foraging and food-getting between species is in parallel with the complement of habitats utilized (Hjohngard, 1975). Many species annually migrate from wintering grounds along the Gulf Coast to summer nesting grounds to the north. These summer nesting grounds vary among species, ranging from low tundra in the Arctic to the broad belt across the northern plains of the U.S., which is known as the prairie pothole region (Terborgh, 1989). Water fowl migration pathways have traditionally been divided into four parallel north-south paths, or "Flyways", across the North American continent. These flyways actually consist of a complex series of crisscrossing routes of individual species (Lincoln, 1979). The GOM coast serves as the southern terminus of both Central (Texas) and Mississippi (Louisiana, Mississippi, and Alabama) flyways. Many waterfowl species are to be found either offshore on large embayments during winter months, or while passing through during spring and autumn migrations. Other species prefer inshore areas, primarily the coastal marshes (Clapp et al., 1982).

Except for certain pochards such as redheads, most wintering waterfowl along the Gulf Coast are neither static nor confined to any specific area on the coast. Ongoing modification of wetland habitats throughout the coastal region is thought to be partly responsible for declines in the populations of wintering waterfowl (Woolington, 1988).

5. *Commercial Fisheries*

The Gulf of Mexico provides nearly 20% of the commercial fish landings in the continental United States. During 1991, commercial landings of all fisheries in the Gulf totaled nearly 1.5 billion pounds valued at about \$641 million.

Menhaden, with landings of 1.2 billion pounds, valued at \$41 million, was the most important Gulf species in quantity landed during 1991. Shrimp, with landings of 229 million pounds, valued at \$411 million, was the most important Gulf species in value landed during 1991. The 1991 Gulf oyster fishery accounted for 43% of the national total with landings of 13.7 million pounds of meats, valued at about \$35.5 million. The Gulf blue crab fishery

accounted for 29% of the national total with landings of 65.4 million pounds, valued at \$23.5 million.

Alabama ranked last among Central and Western Gulf states in total commercial landings for 1991 with 13.6 million pounds landed, valued at \$18.3 million. Shrimp was the most important fishery landed, with 6.5 million pounds, valued at \$14.2 million. In addition, during 1991, the following six species each accounted for landings valued at over \$125,000: blue crab, shark black mullet, red snapper, flounder, and the American oyster. Alabama had about 3,470 and 2,515 commercial saltwater, licensed fishermen during 1991 and 1992, respectively.

Mississippi ranked second among Central and Western Gulf states in total commercial fishery landings for 1991, with 208.6 million pounds landed, valued at an estimated \$20.5 million. Shrimp was the most important fishery, with 6 million pounds landed, valued at about \$9.6 million. Menhaden landings during 1991, are estimated at 200 million pounds landed, valued at \$9.4 million. In addition, during 1991, the following four species each accounted for landings valued at over \$150,000: red snapper, blue crab, American oyster, and black mullet. In 1991 and 1992, Mississippi had about 3,329 and 2,515 commercial saltwater, licensed fishermen, respectively.

Louisiana ranked first among Central and Western Gulf states in total commercial fishery landings for 1991, with nearly 1.2 billion pounds landed, valued at \$163.4 million. Menhaden was the highest quantity finfish, with 1.0 billion pounds landed, valued at \$48 million. Shrimp was the highest value shellfish, with 27.3 million pounds landed, valued at \$36.7 million. In addition, during 1991, the following nine species each accounted for landings valued at over \$1 million: black drum, red mullet roe, shark, red snapper, spotted seatrout, bluefin tuna, yellowfin tuna, blue crab, and the American oyster. In 1991 and 1992, Louisiana had about 19,923 and 19,241 commercial saltwater, licensed fishermen, respectively.

The Gulf of Mexico yielded the nation's second largest regional commercial fishery by weight in 1991. The Gulf Fisheries landing were 20% of the national total by weight and 20% by value. Most commercial species harvested from Federal waters of the Gulf of Mexico are considered to be at or near an overfished condition. Continued fishing at the present levels may result in rapid declines in commercial landings and eventual failure of certain

BEST AVAILABLE COPY

BEST AVAILABLE COPY

BEST AVAILABLE COPY

fisheries. Commercial landings of traditional fisheries, such as shrimp, red snapper, and spiny lobster, have declined over the past decade despite substantial increases in fishing effort. Commercial landings of recent fisheries, such as shark, black drum, and tuna, have increased exponentially over the past five years, and those fisheries are thought to be in need of conservation communication.

The Gulf of Mexico shrimp fishery is the most valuable in the United States accounting for 71.5% of the total domestic production. Three species of shrimp--brown, white,-and pink--dominate the landings. The status of the stocks are as follows: (1) brown shrimp yields are at or near the maximum sustainable levels; (2) white shrimp yields are beyond maximum sustainable levels with signs of overfishing occurring; and (3) pink shrimp yields are at or beyond maximum sustainable levels.

C. *SOCIOECONOMIC CONDITIONS AND OTHER CONCERNS*

1. *Economic and Demographic Conditions*

Identifiable local employment effects will be located in the vicinity of Mobile, Alabama. Onshore support facilities for the proposed operations will be provided by an existing shorebase facility located in Dauphin Island, Alabama.

The principal population and industry centers are Mobile, Alabama and Pascagoula, Biloxi-Gulfport, Mississippi. Services accounted for 23.8% of total payroll for 1992, followed closely by the manufacturing industry accounting for 22.5% of total employment. Mining played a minor role, contributing less than 1% to both employment and payroll. Mississippi and Alabama coastal counties experienced the smallest impact of the 1986 decline in labor force.

Louisiana and Mississippi are expected to continue experiencing steady population growth through the year 2010. Alabama, which was once as densely populated as coastal Texas, is expected to have the lowest population density of the states in the GOM Region by 2010.

Community services in coastal Mississippi and Alabama include hospitals,

BEST AVAILABLE COPY

schools, restaurants, hotels/motels, and utilities. The regional transportation system in coastal Mississippi and Alabama includes roads and highways, railroads, airports and waterways. Interstate 10 and U.S. 90 are the major highways serving the coastal area.

They are parallel to each other along the coast, linking the major urban centers. Rail lines provide coastal and inland access to coastal Mississippi and Alabama. Public airports are located in the major industry centers along the coast. Waterways linking the major ports provide access to international and domestic commerce. Coastal resources in Mississippi include harbors and ports.

2. *Recreation*

The northern Gulf of Mexico coastal zone is one of the major recreational regions of the United States, particularly for marine fishing and beach activities. Gulf Coast shorelines offer a diversity of natural and developed landscapes and seascapes. Major recreational resources include publicly owned and administered areas, such as national seashores, parks, beaches, and wildlife lands, as well as designated preservation areas, such as national seashores, parks, beaches, and wildlife lands, as well as designated preservation areas, such as historic and natural sites land landmarks, wilderness areas, wildlife sanctuaries, and scenic rivers. Gulf Coast residents and tourists from throughout the nation, as well as from foreign countries, use these resources extensively and intensively for recreational activity. Commercial and private recreational facilities and establishments, such as resorts, marinas, amusement parks, and ornamental gardens, also serve as primary-interest areas.

The Gulf States from Texas to Alabama account for about 1.3 million registered motorboats and over 3.5 million paid fishing license holders. The two major recreational areas most directly associated with the offshore leasing and potentially affected by it are the offshore marine environment and the coastal shorefront of the adjoining states. The major recreational activity occurring on the OCS is offshore marine recreational fishing and diving. Studies, reports, and conference proceedings published by MMS and others have documented a substantial recreational fishery, including scuba diving, directly associated with oil and gas production platforms. The recreational fishing associated with oil and gas structures stems from their function as

high profile artificial fishing reefs. The NMFS Marine Recreational Fisheries Statistics Survey for the Gulf and Atlantic Coasts (USDOC, NMFS, 1990a) and a special report by Schmied and Burgess (1987) indicates there are about 4 million resident participants in marine recreational fishing and over 2 million tourists who angle for Gulf marine species. According to NMFS, over 40 percent of the nation's marine recreational fishing catch comes from the Gulf of Mexico, and marine anglers in the Gulf made over 15 million fishing trips in 1991, exclusive of Texas.

Along the coast of Florida, Alabama, and Mississippi there are numerous recreational beaches, parks, refuges, etc. Examination of the MMS' Multiple Use Map (USDOI, MMS, 1994b) indicates that included in these areas are: Gulf Islands National Sea Shore, Fort Pickens Aquatic Preserve, Big Lagoon State Recreational Area, Perdido Key State Recreational Area, Gulf State Park, Bon Secour and Grand Bay National Wildlife Reserves, and Shepard State Park.

These parks, reserves, and recreational areas provide recreational and sporting opportunities for residents and visitors to the area. Recreational fishing is important to the NEGOM coastal residents, visitors and economy.

3. *Cultural Resources*

Existing literature regarding prehistoric and historic archaeological research in the Mobile Bay and Viosca Knoll Areas was reviewed and remote sensing data was evaluated for potential cultural resources indicators. Nonrenewable cultural resources were of primary concern in the assessment, and these resources include possible prehistoric human habitation sites and historic shipwrecks. Prehistoric archaeological sites may exist on former subaerial land forms which were exposed during the late Pleistocene and early Holocene low sea level oscillations. Ships of numerous varieties have carried humans in and out of the Mobile Bay region for hundreds of years, and the vessels that were wrecked in the bay and offshore waters constitute part of an important cultural heritage.

Previous archaeological research in the Mobile Bay region has been reviewed in the works of DeJarnette (1952), Trickey (1958), Curren (1976), and Knight (1977). Stowe and Fuller (1979) have summarized the earliest archaeological investigations in the Mobile Alabama area dating from the "Speculative

BEST AVAILABLE COPY

Period 1492 - 1840" through the "Classificatory-Descriptive Period, 1840 - 1914" (Willey, 1974). In the 1940's, archaeological surveys and excavations were conducted in Mobile and Baldwin Counties by the Alabama Museum of Natural History and the Federal Works Progress Administration (Dejarnette, Anderson, and Wimberly, 1941, and Willey, 1949). Archaeological site surveys, excavations, and cultural resources assessments during the last several decades provide valuable information on the paleogeographic framework for prehistoric human habitations of the region and historic documentation of the shipping activity.

After the Civil War, Mobile continued to be an important port for cotton and lumber trade. Iron, steel, and coal industries in Birmingham depended on transportation of materials through Mobile Bay at the turn of the century, and paper mills increased port traffic during the 20th century. Shipbuilding became a primary industry in the area during World War I, and shipyards are still a basic component of industry in the area. Shrimping and oystering became important mainstays of the modern economy.

Significant cultural resources in the Mobile Bay area include the following properties listed on the National Register of Historic Places: Fort Morgan, U.S.S. Tecumseh, Sand Island Lighthouse, Mobile Point Light Station Keeper's Quarters, and Fort Gaines.

Numerous wrecks, ballast dumps, and obstructions have been reported on Mobile Bay Navigation charts since 1850. Mistovich and Knight (1983) compiled an extensive list of shipwreck locations and potentially significant bottom obstructions in Mobile Bay and offshore State waters based on a baseline literature review and remote sensing survey conducted for the U. S. Army Corps of Engineers, Mobile District. Irion (1986) has reported on the subsequent underwater investigations of 22 magnetic anomalies identified as potentially significant in the Mistovich and Knight (1983) study.

The underwater testing of the selected anomalies in Mobile Bay revealed that all of the anomalies were caused by modern debris. One third of the anomalies were found to be steel cable which is in constant use in the bay for mooring, towing, and lifting lines. Broken cable is continually discarded or lost in the bay. Irion (1986) also pointed out that the small objects dropped in the bay have a high mobility rate because of the large number of shrimp boats working in the area. Commercial shrimpers drag their nets up to an

BEST AVAILABLE COPY

inch below the mudline, and objects resting along the bottom are snagged in the nets. Local shrimpers indicate that some shrimpers prefer the deeper channel waters, while other groups work only on the mud flats. Channel shrimpers dump object snagged in their nets on the mud flats, and the mud flat shrimpers reciprocate by dumping debris in the channel. The result of this exchange mechanism is a constant scattering of debris throughout the bay and offshore waters. Additional activities of crab fishermen compound the distribution of modern debris.

There were four wrecks reported from the general vicinity of the lighthouse two unnamed Spanish vessels, a brigantine, and a settee were stranded at the lighthouse in February, 1780. The Irish Ship "*Napoleon*" was wrecked nearby in 1841, and the schooner "*Almira*" was stranded on Sand Island in March of 1913. The sailing vessel "*Indian Chief*" was sunk southeast of the lighthouse prior to 1916, but the wreck was removed by the U. S. Army Corps of Engineers, because the vessel was obstructing navigation. There is a wreck symbol southwest of the lighthouse on the 1958 edition of Chart 1266, but its identity is undetermined.

In July, 1996, KC Offshore, L.L.C. performed a geophysical survey of Destin Dome Blocks 1 and 2. The magnetometer and side scan sonar records were reviewed for evidence of shipwrecks. The sonar targets were not specific enough to determine whether they constitute shipwreck remains or modern junk, therefore the targets will be avoided during construction. The distribution of the remaining anomalies are not indicative of shipwreck remains.

Archaeological sites that may have existed on the previously exposed upper Pleistocene horizon are likely to have been destroyed by wave action during the transgression of rising sea level. The existing wells have been drilled and re-entry of the boreholes will not impact any prehistoric resources. The existing wells are located inside the "Don Kelly Reef", but there are no significant platform jackets or tanks on the bottom in the area.

4. *Navigation*

Fairways play an important role in the avoidance of collisions on the OCS, particularly in the case of the larger oceangoing vessels, but not all vessels stay within the fairways. Many others, such as fishing boats and OCS

BEST AVAILABLE COPY

support vessels, travel through areas with high concentration of fixed structures. In such cases the most important mitigation factor is the requirement for adequate marking and lighting of structures. After a structure has been in place for a while, it often becomes a landmark and an aid to navigation for vessels that operate in the area on a regular basis. Most ocean going vessels are equipped with radar capable of aiding navigation in all weather conditions. This has contributed to safe navigation on the OCS.

The platforms and each marine vessels servicing these operations will be equipped with all U. S. Coast Guard required navigational safety aids to alert ships of its presence in all weather conditions.

5. *Pipelines and Cables*

As a prudent operator, OEDC Exploration & Production, L.P. will conduct its operations in accordance with the provisions specified in Minerals Management Service Notice to Lessees 91-02 in order to avoid all pipelines and/or cables in the vicinity of the proposed operations.

6. *Ocean Dumping*

The Marine Pollution Research and Control Act of 1987 implements Annex V of the International Convention for the Prevention of Pollution from Ships (MARPOL). Most of the law's regulatory provisions became effective on December 31, 1988. Under provisions of the law, all ships and watercraft, including all commercial and recreational fishing vessels, are prohibited from dumping plastics at sea. The law also severely restricts the legality of dumping other vessel-generated garbage and solid waste items both at sea and in U.S. navigable waters. The USCG is responsible for enforcing the provisions of this law and has developed final rules for its implementation, calling for adequate trash reception facilities at all ports, docks, marinas, and boat launching facilities.

Final rules published under MPPRCA explicitly state that fixed and floating platforms, manned production platforms, and support vessels operating under a Federal oil and gas lease are required to develop Waste Management Plans and to post placards reflecting MARPOL, Annex V dumping restrictions. Waste Management Plans will require oil and gas operators to describe procedures for collecting, processing, storing, and discharging garbage and

BEST AVAILABLE COPY

to designate the person who is in charge of carrying out the plan. These rules also apply to all oceangoing ships of 40 ft or more in length that are documented under the laws of the U. S. or numbered by a State and that are equipped with a galley and berthing. Placards noting discharge limitations and restrictions, as well as penalties for noncompliance, apply to all boats and ships 26 ft or more in length. Furthermore, the Shore Protection Act of 1988 requires ships transporting garbage and refuse to assure that the garbage and refuse is properly contained on board so that it will not be lost in the water from inclement wind or water conditions.

The disposal of oil and gas operational wastes is managed by USEPA through regulations established under three Federal Acts. The Resource Conservation and Recovery Act (RCRA) provides a framework for the safe disposal of discarded materials, regulating the management of solid and hazardous wastes. The USEPA has exempted many oil and gas wastes from coverage under hazardous wastes regulations under Subtitle C of RCRA. If covered, such wastes would be more stringently regulated under hazardous waste rules, i.e., industry would be responsible for the wastes from their generation to their final disposal. Exempt wastes include those generally coming from an activity directly associated with the drilling, production, or processing of a hydrocarbon product. Nonexempt oil and gas wastes include those not unique to the oil and gas industry and used in the maintenance of equipment.

The direct disposal of operational wastes into offshore waters is limited by USEPA under the authority of the Clean Water Act. And, when injected underground, oil and gas operational wastes are regulated by USEPA's third program, the Underground Injection Control program.

A general NPDES, based on effluent limitation guidelines, is required for direct disposal of operational wastes into offshore waters. The major discharges from offshore oil and gas exploration and production activities include produced water, drilling fluids and cuttings, ballast water, and storage displacement water. Minor discharges from the offshore oil and gas industry include drilling-waste chemicals, fracturing and acidifying fluids, and well completion and workover fluids; and from production operations, deck drainage, and miscellaneous well fluids (cement, BOP fluid); and other sanitary and domestic wastes, gas and oil processing wastes, and miscellaneous discharges.

III. *POTENTIAL ENVIRONMENTAL EFFECTS*

BEST AVAILABLE COPY

A. *PHYSICAL ENVIRONMENT*

1. *Effects from Potential Geological Hazards*

Geologic hazards that may occur include sea floor instability, shallow gas in sea floor sediments and active faulting. Geologic hazards pose engineering and operations constraints and can usually be effectively mitigated through existing or new technology and design. Detailed post lease surveying and sampling on a site-specific basis are necessary to fully evaluate hazards in relation to offshore development and operations.

High Resolution Geophysical Surveys were performed in the areas of the proposed operations. The purpose of the surveys was to determine bottom and subbottom conditions within the lease areas and inspect for potential drilling hazards. Remote sensing equipment included a proton precession total field magnetometer, a 100 kHz dual channel side scan sonar, a 24 kHz echo sounder, and a 3.5 kHz subbottom profiler. Seismic data was obtained with a high resolution DFS-V seismic recording system and two 100 cubic inch sleeve guns.

2. *Effects on Air Quality*

The potential degrading effects on air quality from onshore and offshore operational activities are platform emissions; drilling activities during exploration, delineation, and development; service vessel operation; evaporation of volatile hydrocarbons from surface oil slicks; and fugitive emissions during hydrocarbon venting and offloading.

Emissions of pollutants into the atmosphere for these activities are likely to have minimum impact on offshore air quality because of prevailing atmospheric conditions, emission heights, and pollutant concentrations. Onshore impact on air quality from emission from OCS activities is estimated to be negligible because of the atmospheric regime, the emission rates, and distance of these emissions from the coastline. The above discussion is based on average conditions; however, there will be days of low mixing heights and wind speeds that could increase impact levels. These conditions are characterized by formation, which in the Gulf occurs about 35

days a year, mostly during winter. Impact from these conditions is reduced in winter because the onshore winds have the smallest frequency (37%) and rain removal is greatest. Summer is the worst time, with onshore winds having a frequency of 61%. Emissions of pollutants into the atmosphere are expected to have concentrations that would not change the onshore air quality classifications.

3. *Effects on Water Quality*

Impact-producing factors from OEDC's proposed development operations that may lead to offshore water quality degradation include resuspension of bottom sediments through platform and pipeline emplacement and removal; the overboard discharge of operations wastes during drilling, workovers, and production, and from vessel operations; and accidental spills, blowouts, or pipeline leaks.

Emplacement and removal of platforms and pipelines increase water-column turbidity by resuspending bottom sediments. Impacts to water quality from two platform emplacements were studied off California (Arthur D. Little, Inc., 1985). During the installation of the offshore platforms, sediment disturbance and suspension resulted from pile driving and anchoring when foundations for the production platforms were prepared. The operations produced localized, temporary impacts on water quality conditions in the immediate vicinity of the platforms.

Contaminants from vessels transporting oil or supplies to and from the offshore platforms can enter the Gulf through routine operational discharges or accidental spills. Service vessels routinely discharge sanitary and domestic wastes and bilge waters. Estimates of this traffic average one round trip per week for the crew boat and one round trip per week for the supply boat. Given the high level of traffic already occurring in this area of the Gulf, it is not anticipated that the incremental increase in traffic due to the two trips per week of service vessels would result in any incremental change in water quality conditions.

There is a very low probability that a diesel spill may occur from storage tanks or during the transfer of fuel while conducting production operations. The most likely size for a large diesel spill occurrence is assumed to be 500 bbls (loss of all diesel from the largest storage tank used). In the unlikely

BEST AVAILABLE COPY

event that a spill was to occur at the proposed locations, modeling data suggests that within 12 hours of the spill, 53.83% of the slick will have evaporated and 46.17% will be in the water column. Therefore, there is 0% probability that the fuel oil would reach the coastline, based on oceanographic conditions.

The effect on water quality from the oil spills is determined by the amount of oil that resides within the contacted water body. Degradation of open water quality is directly proportional to the aerial extent, the volume, and the residence time of the oil in the water column. Most oil spills impact offshore water quality during the life of the spill and only for a short time afterwards. A number of weathering processes act to remove the oil from the surface of the water and water column within several months. Examination of the weathering of the diesel fuel oil projected to be used shows that the oil is of low volatility and is fairly persistent compared to crude oil spills that occur from GOM OCS operations.

Produced water constitutes the largest single source of material discharged into the Gulf during normal oil and gas operations. Hydrocarbons and metals associated with the plume have been shown to adsorb onto sediment particles in the water column and settle to the sea floor or contaminate the sea floor directly through bottom impact from the discharge plume, depending on the water depth.

Based on the USEPA's review of past field studies, moderate petroleum and metal contamination of sediments appears to have occurred from the past produced-water discharges, generally out to several hundred meters downcurrent from the discharge point, possibly out to 1000 m. Discharges of produced water are continuous discharges (10-30 years) creating a potential for longer exposure periods for accumulation of petroleum hydrocarbons in platform-associated sediments (Avant Corporation, 1993).

Petroleum hydrocarbons, metals, and radium were often detected in the water column at some distances downcurrent from the discharge point. All of the studies found that the salinity plume made by the produced water was dispersed very rapidly.

Produced hydrocarbons from the production of OEDC's proposed wells are expected to be dry gas (99% methane) with no condensate. Produced water

discharges, if any, will be discharged from OEDC's existing A platform located Mobile Block 960. OEDC will monitor the discharges in accordance with the Effluent Limitation Guidelines and New Source Performance Standards for the offshore oil and gas industry.

The operations of the onshore support base at Dauphin Island, Alabama, and the commercial waste disposal facilities located in Mississippi or Alabama may impact coastal water quality by routine point- and nonpoint-source discharges. Process, cooling, boiler, and sewage water effluents are discharged during the life of the existing infrastructure and facilities. Effluents from onshore infrastructure are commonly discharged into surface waters after treatment. Anti-fouling marine paints used on vessels and structures at the service base and marine terminal can be spilled or enter the marine environment slowly through deterioration of the painted surfaces. Domestic wastewater will be collected and delivered to a municipal treatment plant or will receive secondary treatment in an on-site package treatment plant.

The greatest cause of contamination from support facilities has been identified as non-point pollution. Runoff from support facilities is likely to contain oil, particulate matter, heavy metals, petroleum products, process chemicals, fecal coliform, high nutrient loadings, and would affect local streams, estuaries, and bays, causing elevations of the contaminants in the surrounding waters, low dissolved oxygen levels, and high turbidity. The facility's presence, along with the associated access routes, alters the natural hydrology and geography of the area over time, resulting in increased erosion and land loss. The facility may also alter circulation in wetland areas and may affect flushing rates and salinity gradients, resulting in salt water intrusion.

Vessel usage of coastal waters near Dauphin Island may degrade water quality from bilge water discharges, discharges of treated sanitary and domestic wastes, wake erosion of channel banks, trash and debris loss, and spills. New MARPOL regulations severely restricting the levels of oil and grease in bilge water discharges in coastal areas (40 CFR 110) should diminish the types of impacts that have been historically noted from such discharges. Spills are most likely to occur in connection with the offloading and onloading and fueling activities associated with the support boat support.

BEST AVAILABLE COPY

BEST AVAILABLE COPY

A portion of the wastes generated from OEDC's proposed operations will be brought ashore for disposal. These wastes can be contaminated with toxic or hazardous compounds, heavy metals, and oil and grease. Once ashore, these wastes will be transported via barge or truck to several disposal facilities located in either Mississippi or Alabama for off-site storage and disposal.

The improper transportation, storage, treatment, and disposal of oilfield solid wastes and discarded, contaminated oilfield equipment brought onshore could adversely impact surface and groundwater in proximity to storage sites, disposal facilities, cleaning sites, scrap yards, and metal reclamation yards.

Historically, improper operations or maintenance of facilities handling oilfield pipe and equipment have been shown to have caused adverse impacts to surrounding waters, particularly from elevated concentrations of heavy metals, petroleum hydrocarbons, and NORM. Because of regulatory restrictions to prevent such contamination by the State of Alabama and Mississippi, and new precautions now being taken by the oil industry, historical contamination conditions should not be indicative of future trends and are expected to greatly improve over time despite continued oilfield waste disposal operations.

B. *BIOLOGICAL ENVIRONMENT*

OEDC contracted SpillNet, Inc. to prepare Environmental Sensitivities Maps for the affected coastline from Biloxi, Mississippi to Pensacola, Florida. The maps identify the reefs, fish, invertebrates, reptiles and amphibians, mammals, raptors, seabirds, shorebirds, songbirds, wading birds, waterfowl and plants that could be affected by OEDC's proposed development operations in the Destin Dome Area.

The Environmental Sensitivities Overview Map and Environmental Sensitivities Maps 1 through 8 are included with the Initial Development Operations Coordination Document.

1. *Effects on Coastal Habitat*

The major impact-producing factors associated with the proposed operations that could affect barrier beaches include oil spills, pipeline emplacements,

BEST AVAILABLE COPY

navigation canal dredging and maintenance dredging, and support infrastructure construction. This section considers impacts to the physical shape and structure of barrier beaches.

Most inland spills are assumed to occur as a result of coastal transport accidents largely during transfer operations at terminals. Onshore, OCS operations and most OCS-related waterway segments related to this activity are located away from barrier beaches and dunes.

When transporting fuel to an offshore location, barges will use interior waterways to get to the open Gulf. These waterways are usually remote from barrier beaches. A typical inland vessel accident could result in spilled hydrocarbons contacting inland shores of barrier islands, but will unlikely adversely impact barrier beaches or dunes. For an inland barge accident to affect a barrier beach significantly, the accident would have to occur in offshore state waters, on a barrier landform in close proximity to a beach, or inshore in the vicinity of a tidal inlet.

The trajectory for a "worst case" scenario presents descriptions, probabilities, and estimates for offshore spills that may occur as a result of the proposed operations. Because of the low probabilities and mitigative measures imposed on the operator, an offshore spill related to the proposed operations is not expected to contact a coastal barrier beach or dunes.

Effects on Wetlands and Seagrasses

Wetlands considered in this analysis include forested wetlands (bottomland and swamp) and marshes. Seagrass beds are also included. Seagrasses are restricted in distribution to small shallow areas behind barrier islands in Mississippi and Chandeleur Sounds. Numerous investigators have studied the immediate impacts of oil spills on wetland habitats in the GOM area. Often, seemingly contradictory conclusions from impact assessments are generated from these studies. This can be explained by differences in oil concentrations contacting vegetation, the kinds of oil spilled (heavy or light crude, diesel, fuel oil, etc.), types of vegetation affected, the season of year, the pre-existing stress level of the vegetation, soil types, and numerous other factors. In overview, the data suggests that light-oiling impacts will cause plant die-back with recovery within two growing seasons or less without artificial replanting. Therefore, most impacts to vegetation are considered

short term and reversible (Webb et al., 1985; Alexander and Webb, 1987; Lytle, 1975; Delaune et al., 1979; Fischel et al., 1989).

The trajectory for a "worst case" scenario presents descriptions, probabilities, and estimates for offshore spills that may occur as a result of the proposed operations. The probability of offshore spills impacting barrier beaches is described as being very low.

Because wetlands and grassbeds in the region of influence are found inland of islands and sand spits or in bays, the probability of an oil spill impacting coastal wetlands or grassbeds, the impacts would be very slight, without significant plant mortality, and allowing recovery within a year. Project-related spills can also occur inshore as a result of navigation and fuel transfer accidents. Most of these oil spills will be assumed to be confined and managed as a result of spill prevention and control plans required for transfer facilities, thereby causing no significant impacts on wetlands.

Larger inland spills may result from navigation accidents, away from transfer facilities. Inland spills will be largely contained in the channel, where slicks will spread through the channel by tidal, wind, and traffic generated currents. Most oil effects on significant areas of wetland vegetation. Spills that damage wetland vegetation fringing and protecting canal banks will accelerate erosion of those once protected wetlands and spoilbanks (Alexander and Webb, 1987).

Seagrass beds in the area of influence generally occur in shallow, high-salinity waterbodies, landward of protective landforms, such as barrier islands, sand spits, and shoals. Seagrasses generally occur at depths of 50 cm or less. Seagrasses have generally experienced minor damage from oil-spill occurrences (Zieman et al., 1984; Chan, 1977). The relative insusceptibility of seagrasses to oil-spill impacts is partly the result of their subtidal location in a region with a micro-tidal range. The lack of low tide exposure protects them from direct contact with oil. The degree of impact will depend on water depth and tidal events in the affected area during the presence of floating oil. Insusceptibility of seagrasses to oil spills is also a result of a large percentage of their biomass being in the roots and rhizomes, which are buried in sediment, from which the leaves generate. An oil spill that moves into a seagrass area will be expected to cause slight damage to the vegetation. Because of shallow depths, a spill in the vicinity of a bed is expected to cause

BEST AVAILABLE COPY

BEST AVAILABLE COPY

3. *Effects on Endangered, Threatened, and/or Protected Species*

Effects on Sea Turtles

Generic impacts of noise from OCS-related activities are discussed in USDOJ, MMS (1994). Sea turtles may be injured or killed after being entangled in plastic debris (USDOJ, MMS, 1994). Jellyfish are eaten by all five species of sea turtles, especially leatherbacks. The five species may ingest plastic debris that resemble jellyfish such as six-pack rings. Lethal and sublethal impacts may follow (USDOJ, MMS, 1994). However, the proposed action is not expected to result in impacts from ingestion of plastic debris or entanglement in it by sea turtles. No impacts should occur because the MMS prohibits disposal of debris into offshore waters by lessees (30 CFR 250.40.).

Potential impacts of coastal facility construction on turtle nesting beaches are discussed in USDOJ, MMS (1984). No impacts from construction are expected.

If a hydrocarbon spill would occur, the severity of effects and the extent of the damage to marine turtles would be characterized by geographic location, oil type, impact area, oceanographic conditions, meteorological conditions, and season (NRC, 1985; USDOJ, MMS, 1987b). Oil spills can adversely affect marine turtles by toxic external contact, toxic ingestion or blockage of the digestive tract, disruption of salt gland function, asphyxiation, and displacement from preferred habitats (Vargo et al., 1986; Lutz and Lutcavage, 1989). Mitigative measures imposed on the operator should reduce the risk of a spill occurring and facilitate the containment and clean up of the spilled hydrocarbon limiting the potential effects to marine turtles.

Oil-spill response activities, such as vehicular and vessel traffic in shallow areas of seagrass beds and live-bottom communities, can adversely affect sea turtle habitat and cause displacement from these preferred areas. Oil spills and oil spill response activities, such as beach sand removal, can negatively affect marine turtles.

Effects on Birds

Activities resulting from the proposed operations have the potential to affect NEGOM coastal and marine birds detrimentally. It is expected that the

BEST AVAILABLE COPY

effects from the major impact-producing factors on coastal and marine birds are negligible and of nominal occurrence. As a result, there will be no discernible disturbance to Gulf coastal and marine birds.

The brown pelican, arctic peregrine falcon, bald eagle, and piping plover may be impacted by helicopter and service-vessel traffic, offshore pipeline landfalls, entanglement in and ingestion of offshore oil- and gas-related plastic debris, and oil spills. The effects of these operations are expected to be sublethal. Oil spills of any size are expected to seldom contact threatened and endangered birds or their critical feeding, resting, or nesting habitats.

The roseate tern is a transient in the affected area and will not be analyzed. Similarly, for the least tern only the population nesting in the interior is endangered, so the species will not be analyzed.

The southeastern snowy plover is a candidate species in Alabama and Florida. The piping plover is threatened there. Plovers flying at high altitudes may collide with helicopters of the proposed action. Density of plovers is expected to be low; for example, in some cases snowy plover nests were less than 2 per km (Gore and Chase, 1989). Therefore impacts of helicopters are expected to be very low. Plovers may consume beach trash or become entangled in it, causing sublethal or lethal effects. However, 250 CFR 250.40 prohibits disposal of trash in the water during OCS operations. Therefore, impacts from disposal of trash by personnel of OCS-related activities are not expected.

Effects of Hydrocarbon Spills on All Birds

The magnitude of impact to birds following an oil spill depends on the size of the local bird population (oftentimes a function of season), their foraging behavior(s), whether or not the population is aggregated or dispersed into smaller subunits at the time of the spill, and the quantity of oil spilled and its persistence in the environment (NRC, 1985). The birds most vulnerable to direct effects include those species that spend most of their time swimming on and under the sea surface, and often aggregate in dense flocks (Piatt et al., 1990; Vauk et al., 1989). This group includes loons, grebes, sea ducks and pochards, and cormorants. Coastal birds, including shorebirds, waders, marsh birds, and certain waterfowl, may be the hardest hit indirectly through destruction of their feeding grounds and /or food source if the spilled oil

reaches their habitat (Hansen, 1981; Vermeer and Vermeer, 1975). Mitigative measures are in place to lower the risk of spilled hydrocarbon from reaching these habitats.

Effects on Large Whales

Humpback whale sightings indicate the species is only transient in the area of the proposed action, so the species will not be analyzed.

Effects on Other Marine Mammals

Hydrocarbon spills and spill response activities can adversely affect cetaceans. Direct contact with hydrocarbons can lead to irritation and damage of skin and soft tissues. Studies by Geraci and St. Aubin (1982 and 1985) have shown, however, that the cetacean epidermis functions as an effective barrier to noxious substances found in petroleum. Unlike other mammals, penetration of such substances in cetacean skin is impeded by tight intercellular bridges, the vitality of the superficial cells, the thickness of the epidermis, and the lack of sweat glands and hair follicles (Lofflan, personal communication, 1993). Inhalation of vapors can lead to irritation of respiratory membranes, lung congestion, and pneumonia (Geraci and St. Aubin, 1982; Hansen, 1985; Geraci, 1990).

The probable effects on cetaceans swimming through the area would depend on a number of factors, including ease of escape from the vicinity, the health of the individual animal, and its immediate response to stress (Davis, personal communication, 1993; Wursig, personal communication, 1993). Spilled oil can also lead to the reduction or contamination of prey and temporary displacement from migratory routes. An analysis of stomach contents from captured and stranded odontocetes suggest that they are deep-diving animals, feeding predominantly on mesopelagic fish and squid or deep water benthic invertebrates (Heyning, 1989; Mead, 1989). Delphinids feed on fish and/or squid, depending upon the species (Mullin et al., 1991).

Reactions of cetaceans to spilled oil are varied, with evidence of both direct avoidance and obvious indifference in even heavily oiled areas. Several observations of cetaceans confronting spilled oil show them in the vicinity, and in some cases in the midst of a spill, behaving quite normally. At present, it is unknown whether these animals in such cases are simply not

BEST AVAILABLE COPY

affected by the presence of oil, or perhaps are even drawn to the area in search of prey organisms attracted to the oil's protective surface shadow (Geraci, 1990). Controlled experiments on detection and avoidance response of bottlenose dolphin to oil films showed that dolphins can see oil at the surface and that they prefer to avoid it (Geraci et al., 1983; Smith et al., 1983; St. Aubin et al., 1985).

In the event that "oiling" of cetaceans should occur from a spill associated with the proposed operations, the effects would be primarily sublethal.

Effects on Beach Mice

Beach mouse subspecies of the old field mouse that live in the area of the proposed action are the Alabama, Perdido Key, Choctawhatchee, St. Andrew, and Santa Rosa subspecies. Beach trash and debris could be eaten by mice or could entangle them in their foraging habitat behind the dunes, causing sublethal or lethal impacts. However, no impacts from OCS-related activities are expected because the MMS prohibits disposal of debris into offshore waters by lessees (30 CFR 250.40).

Direct contact with spilled oil can cause skin and eye irritation, asphyxiation from inhalation of toxic fumes, food reduction, food contamination, oil ingestion, and displacement from preferred habitat. Vehicular traffic and activity associated with oil-spill cleanup activities can degrade preferred habitat and cause displacement from these areas, or it can attract predators. Because the preferred habitat of Alabama, Choctawhatchee, and Perdido Key beach mice is behind the barrier dunes, an oil spill would have to breach the dunes to reach either the mice or their preferred habitat. This could occur only if an oil spill coincided with a storm surge.

Effects on Gulf Sturgeon

The Gulf sturgeon may be impacted only by oil spills. The discussion presented below on effect to commercial fisheries is germane to the Gulf sturgeon.

In summary, impacts of the proposed action on endangered species are expected to be very low.

BEST AVAILABLE COPY

4. *Effects on Commercial Fisheries*

The most significant potential effects on commercial fisheries would come from an accidental hydrocarbon release. The direct effects of spilled oil on fish occur through the ingestion of oil or oiled prey, through the uptake of dissolved petroleum products through the gill and epithelium by adults and juveniles, and through death of eggs and decreased survival of larvae (NRC, 1985). Upon exposure to spilled oil, liver enzymes of fish oxidize soluble hydrocarbons into compounds that are easily excreted in urine (Spies et al., 1982). Adult fish must experience continual exposure to relatively high levels of hydrocarbons over several months before secondary toxicological compounds that represent biological harm are detected in the liver (Payne et al., 1988). Observations at oil spills around the world consistently indicate that free-swimming fish are rarely at risk from oil spills (Anon., 1991c; NRC, 1985).

Behavior studies of several fish species suggest that adults are likely to actively avoid an oil spill, thereby limiting the effects and lessening the extent of damage (Baker et al., 1991; Malins et al., 1982).

The effects on and the extent of damage from an oil spill to Gulf fisheries is restricted by time and location. Oil spills that contact coastal bays, estuaries, and waters of the OCS when pelagic eggs and larvae are present have the greatest potential to affect commercial fishery resources. Migratory species, such as mackerel, cobia, and crevalle, could be impacted if oil spills contact nearshore open waters. An oil spill contacting a low-energy inshore area would affect commercial fishery resources, such as menhaden, shrimp, and blue crabs.

Ordinary environmental stresses may increase the sensitivity of fish to oil toxicity. These stresses may include changes in salinity, temperature, and food abundance (Evans and Rice, 1974; NRC, 1985). For OCS-related oil spills to have an effect on a commercial fishery resource, whether estuary dependent or not, eggs and larvae would have to be normally concentrated in the immediate in highly toxic concentrations when both eggs and larvae are in the pelagic stage (Longwell, 1977). There is no evidence at this time commercial fisheries in the Gulf have been adversely affected on a regional population level by spills.

BEST AVAILABLE COPY

Large numbers of fish eggs and larvae have been killed by oil spills. However, fish over-produce eggs on an enormous scale and the overwhelming majority of them die at an early stage, generally as food for predators. Even a heavy death from an oil spill has no detectable effect on the adult population, which is exploited by a commercial fishery. This has been confirmed during and after the *Torrey Canyon* spill off southwest England and the *Argo Merchant* spill off Nantucket. In both cases, a 90 percent death of fish eggs and larvae, pilchard and pollack, respectively, was observed in the affected area, but this had no impact on the regional commercial fishery (Baker et al., 1991).

C. *SOCIOECONOMIC CONDITIONS AND OTHER CONCERNS*

1. *Effects on Economic and Demographic Conditions*

Effects on Local Employment

It is estimated that up to six people will be utilized at the shore base (Dauphin Island, Alabama) in support of the proposed operations. Two permanent contract employees will man the shore base. They will rotate on a 7-days on/7-days-off schedule. The four part-time contract positions could be filled by local (Alabama) residents, depending upon personnel availability, qualifications, etc.

It is estimated that additional employees will be required for supply boat, crew boat and standby operations. The vessel crews will not require local housing as they will usually live on their respective vessels while working in the area and will return to their residence upon completion of each tour of duty. Some deck hands may be hired from the local labor pool.

Some of the service firm employees may be hired locally. Most of these employees will return to their places of residence on their days off.

There is a very slight possibility of a diesel spill associated with the proposed operations. Based on historical occurrences and converted to probabilities, there is a 0.67 percent probability of a diesel spill greater than one but less than 50 bbls occurring; and a 0.13 percent probability of a diesel spill over 50 bbls occurring. A "worst case" spill scenario for OEDC's proposed

BEST AVAILABLE COPY

BEST AVAILABLE COPY

operations is a total spill amount of 500 bbls of diesel fuel. A trajectory analysis indicates probabilities of contact with land to be 0%.

To summarize, the proposed operations will require additional personnel. Normally, most of these employees return to their homes in Louisiana, Texas, or other states when their tour of assignment is complete. Some may remain in the local area during their off-duty periods. No new families are expected to move permanently into the vicinity of Mobile as a result of the proposed action. While a few employees may be hired from the local labor pool, impacts to labor resources are expected to be negligible. In the unlikely event of a diesel spill contacting land, approximately 500 cleanup workers would come from companies with existing contracts and, if necessary, from existing labor pools in the Gulf region. It is expected that temporary cleanup workers would return to their homes following the completion of cleanup activities.

Effects on Local Population and Industry Centers

At the end of their respective tours of duty, the personnel manning the shore base would return to their places of residence. While on location, these employees would be in temporary quarters either at the onshore base or in a local motel. Vessel crews, including any transient personnel, would not require local housing, as they would live on the vessels and would return to their residences upon completion of each tour of duty. Contracted personnel would be housed in a local motel by the contract operator while on duty and would return to their homes in Louisiana, Texas, or other states when their tour of assignment is completed. Some may remain in the local area during their off-duty period. No new families are expected to move into the vicinity of the shore base (Racal Survey, 1987).

Because most of the personnel would be returning to their places of residence during their off-duty shifts, no significant effects on population centers and industry are expected to result from the proposed activity. Expenditures associated with operations at the shore base facility could contribute funds to the local and state economy. The existing facilities at the shore base are sufficient to engage in operations required to implement the proposed operations. No new support facilities will be required and no new land acquisition or expansion of existing support bases is anticipated as a result of the proposed operations.

In the unlikely event of a diesel spill contacting land, beach cleanup personnel are typically housed locally in hotels, motels, or temporary residences. The Site Specific OSCP states that OEDC Transportation Logistics Team will be responsible for ensuring that staging areas are established to service various operational areas and for making quartering and meal accommodations for personnel. Such operations would last less than 6 weeks. While the potential for impact is low, should such contact occur there could be a temporary need for housing of spill cleanup personnel.

2. *Effects on Land Use*

OEDC will utilize an onshore support base located at Dauphin Island, Alabama for the proposed operations. These facilities consist of commercially available public or private dockage. No new land areas are expected to be occupied and no increased demands on existing dock space would be anticipated.

In the unlikely event of a diesel spill, there could be increased demands on existing dock space related to dockage of spill cleanup-related vessels. The degree of demand would increase with the size of the spill.

Significant amounts of commodities to be purchased include materials specialized for the development and production operations.

The vendors who would supply these materials have not all been determined, but it is expected that supplies will come from vendors in the Gulf Coast area, including specifically Alabama, Mississippi, Louisiana, and Texas. Specialized services and materials would be used during development operations. Many would be imported for the operations or would exist in the area expressly for servicing such operations. It is expected that their use would not affect community demands for goods and services. Demands on typical local services and materials would be periodic and relatively small, therefore these demands would not be expected to significantly affect supplies in the area of the shore base.

In the unlikely event of a diesel spill contacting land, supplies such as food, drinks, clothing, etc. may be necessary in greater amounts than projected for the proposed operations, and from areas outside the shore base. These demands on typical local services and equipment would be temporary

(perhaps 6 weeks). As the areas with the greatest potential for impact include those areas which are tourism focused, and which typically see fluctuation in population associated with the influx of tourists, the demands would not be expected to significantly affect supplies in the areas.

Additional details of the types of vendors/contractors and specific demands for goods and services which could be required to conduct the planned activities are discussed in the Area-Wide Environmental Report (CSA, 1984). Short-term demands for such specialized services and materials associated with the proposed activity should not affect local supplies significantly.

3. *Effects on Recreation/Tourism*

The proposed operations are located approximately 17 miles offshore and are temporary in nature. Aesthetic impacts are therefore not expected to be significant. Impacts to recreational fisheries are also expected to be insignificant due to both distance from shore and the temporary nature of the activities.

In the unlikely event of a diesel spill with land contact occurring, differential effects on recreation and tourism would be expected. These differential effects would relate to (1) the amount of beach which was impacted, (2) the duration of the cleanup efforts, and (3) the season in which the spill occurred.

4. *Effects on Cultural Resources*

As mentioned above, the area of the proposed activities is considered to have a low potential for the occurrence of submerged prehistoric archaeological sites and historic shipwrecks. Therefore no impacts to offshore cultural resources are expected. Existing onshore support facilities will be utilized. Therefore, no impacts to onshore cultural resources are expected. Operational regulations under 30 CFR 250.26 provide further safeguards for the protection of known, or discovered, cultural resources.

Should cultural resources be encountered, the operator is required to report such to the Regional Director, MMS, and make every reasonable effort to preserve and protect that resource.

5. *Effects on Navigation*

OEDC proposes to use only one 180 ft supply boat, one 120 ft crew boat and one 120 ft utility boat to support the proposed production operations. OEDC anticipates that the supply boat will make no more than one round trip per week from the shore base to the site. Travel frequency for the crew boat is expected to average one round trip per week. Once on location, the utility boat will remain on location at the site. Vessels will use the most practical, direct routes to the site from the shore base. This minimal vessel traffic is insignificant when compared with the marine traffic in the Mobile Area.

6. *Effects From the Military Warning Area*

OEDC has contacted the Naval Air Station in Pensacola regarding the control of electromagnetic emission and operations of boats and/or aircraft into the designated Military Warning Area W-155A or enter into an agreement with the military installation. This will minimize potential multiple use conflicts on the OCS. No environmental effects are anticipated from compliance with this lease stipulation.

7. *Effects on Other Commercial or Mineral Uses*

Since the MMS is not aware of any other planned commercial or mineral uses within the area of the proposed operations, no environmental effects are anticipated to or from the proposed operations.

8. *Effects From Ocean Dumping*

The MMS's regulations prohibit the disposal of objects overboard (30 CFR 250.40). These regulations also require the marking of equipment and other large items prior to shipment offshore. In addition, operators must remove all obstructions and clear the drill site [30 CFR 250.112 (I)]

D. ACCIDENTAL HYDROCARBON DISCHARGES

1. *Spill Response Strategies*

In conducting oil and gas operations in the Gulf of Mexico, OEDC is

committed to the prevention of pollution. The focus of OEDC's Spill Response Program is prevention. However, should an oil spill occur, this OSCP is designed to help company employees respond quickly, safely and effectively to reduce damage to property and the environment. Response to an oil spill will require immediate notification to federal and state agencies. It will also require assembly of the Oil Spill Management Team, and possible mobilization of the Oil Spill Response Operating Team and spill response equipment.

OEDC is a member of Clean Gulf Associates. Through this association, all companies listed in OSCP have access to oil spill equipment along the gulf coasts of Louisiana, Alabama, Florida, Mississippi and Texas and would utilize this equipment along with all necessary third party services, as required for the cleanup of a major spill.

2. *Spill Response Training*

The Incident Commander and Alternates receive annual classroom training for familiarization with containment and recovery equipment, call-out procedures, the location and intended use of available response equipment, spill reporting procedures and deployment strategies. The Oil Spill Response Operating Team attends annual drills for familiarization with pollution control equipment or operations procedures. Additionally, a Spill Management Team tabletop exercise is also held on an annual basis.

3. *Notification Procedures*

Any person who sees oil or any other pollutant in/on the water in the vicinity of OEDC's operations will immediately report the incident to the person-in-charge who will then notify the Incident Commander. The Incident Commander or his designate will contact the appropriate government agencies and supply the information on the Oil Spill Report Form.

4. *Area Services and Contractors*

There is a very slight possibility of a diesel spill associated with the proposed operations. However, in the unlikely event of a diesel spill contacting land, approximately 500 cleanup workers would come from companies with existing contracts, and if necessary, from existing labor pools in the Gulf

region. While on location, these employees would be in temporary quarters either at the onshore base or in a local motel.

Additional supplies such as food, drinks, clothing, etc, may be necessary during cleanup operations. These demands on typical local services and equipment would be temporary.

E. SUMMARY

The proposed operations will be carried out and completed with the guarantee of the following items.

The best available and safest technologies will be utilized throughout the project. This includes meeting all applicable requirements for equipment types, general project layout, safety systems, and equipment and monitoring systems.

All operations are covered by a Minerals Management Service approved Oil Spill Contingency Plan.

All applicable Federal, State, and Local requirements regarding air emission and water quality and discharge for the proposed activities, as well as any other permit conditions, will be complied with.

The proposed activities described in detail in the Initial Development Operations Coordination Documents will comply with Florida's and Alabama's Coastal Management Program and will be conducted in a manner consistent with such Program.

BEST AVAILABLE COPY

BIBLIOGRAPHY

- Churgin, J. and S.J. Halminski. 1974. Temperature, salinity, and phosphate in waters off United States, Vol. II, Gulf of Mexico. Key to oceanographic records No. 2. National Ocean. Data Center, NOAA, 117 pp
- Dinnel, S.P. 1988. Circulation and sediment dispersal on the Louisiana-Mississippi-Alabama continental shelf; Ph.D. Dissertation. Louisiana State University. xii + 173 pp.
- Dynalysis of Princeton. 1993. A bathymetric and hydrographic climatological atlas for the Gulf of Mexico. Draft Report No. 109, submitted to MMS under the Coastal Ocean Modeling contract.
- Kelly, F. J. 1991. Physical oceanography/water mass characterization. In Mississippi-Alabama continental shelf ecosystem study; data summary and syntheses, Vol. II: Technical Narrative. J.M. Brooks ed. OCS Report/MMS 91-0063, U.S. Dept. of the Interior, Minerals Management Service, Gulf of Mexico OCS Regional Office, New Orleans, LA 862 pp.
- Research Planning Institute, Inc. No date. Sensitivity of coastal environments and wildlife to spilled oil Alabama atlas. Prepared for National Oceanic and Atmospheric Administration, Office of Oceanography and Marine Assessment. Columbia, SC Maps 8, 17-20.
- U. S. Department of the Interior, Minerals Management Service. 1995. Gulf of Mexico Sales 157 and 161: Central and Western Planning Areas. Final Environmental Impact Statement, OCS EIS/EA MMS 95-0058, Gulf of Mexico Region, New Orleans; LA.
- U.S. Department of the Interior, Minerals Management Service. 1995. Final site-specific environmental assessment, Revised Exploration Plan No. R-3012U, Destin Dome, Block 57 (Lease OCS-G 6407). Gulf of Mexico OCS Region, New Orleans, LA.

BEST AVAILABLE COPY

**COASTAL ZONE MANAGEMENT
CONSISTENCY CERTIFICATION
DEVELOPMENT OPERATIONS COORDINATION DOCUMENT**

Destin Dome Blocks 1 and 2

OCS-G 6397/6398

The proposed activities described in this Plan comply with Alabama's approved Coastal Zone Management Program and will be conducted in a manner consistent with such Program.

OEDC EXPLORATION & PRODUCTION, L.P.

Lessee or Operator

Joseph L. Lowrey

Certifying Official

September 21, 1996

Date

BEST AVAILABLE COPY

COASTAL ZONE MANAGEMENT

CONSISTENCY CERTIFICATION

DEVELOPMENT OPERATIONS COORDINATION DOCUMENT

Destin Dome Blocks 1 and 2

OCS-G 6397/6398

The proposed activities described in this Plan comply with Florida's approved Coastal Zone Management Program and will be conducted in a manner consistent with such Program.

OEDC EXPLORATION & PRODUCTION, L.P.

Lessee or Operator

Joseph L. Devoy

Certifying Official

September 21, 1996

Date

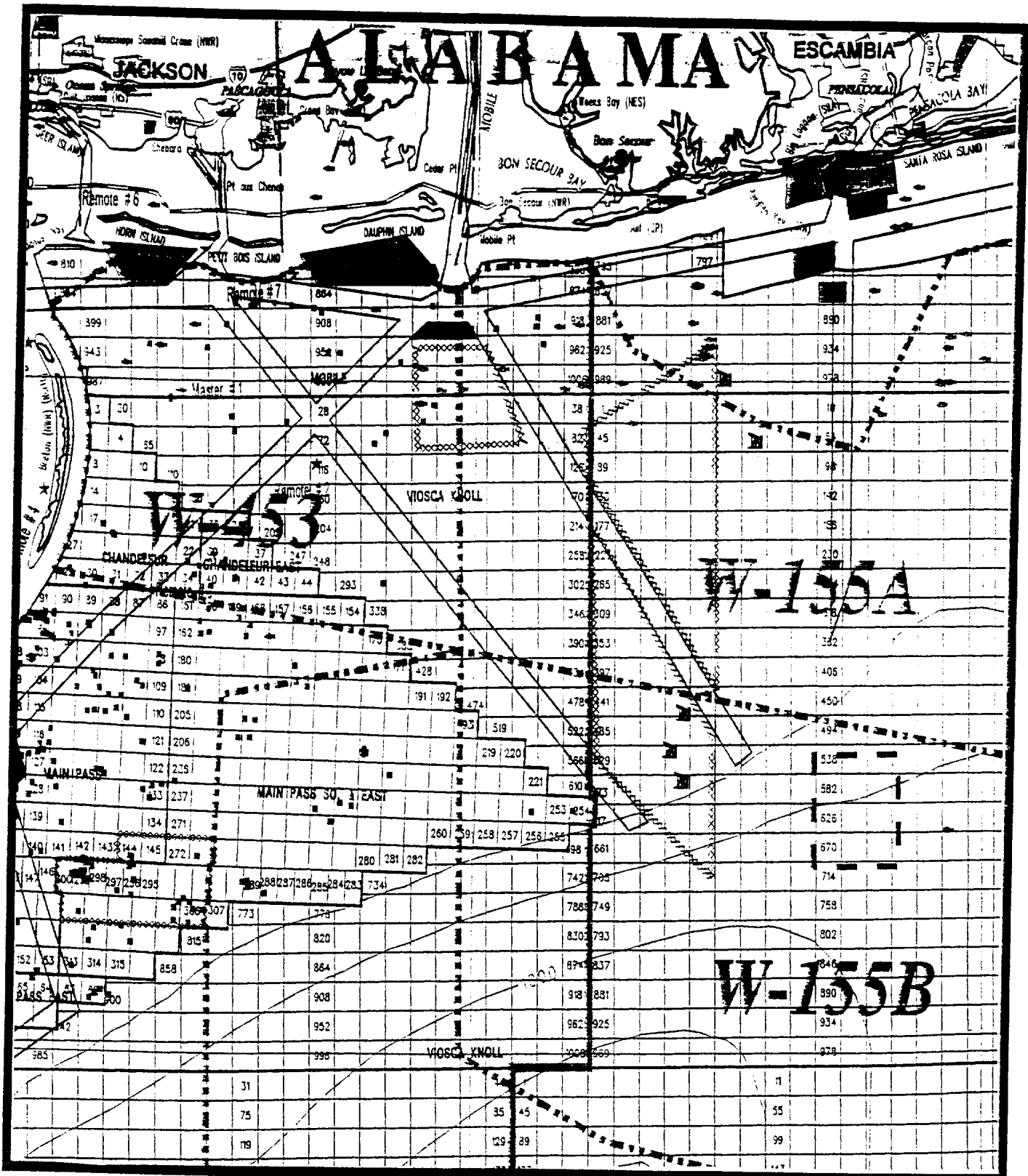

BEST AVAILABLE COPY

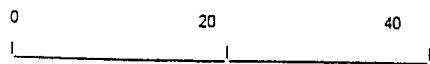

SCALE

OEDC EXPLORATION & PRODUCTION, L.P.

DESTIN DOME BLOCKS 1 AND 2
VICINITY PLAT

SHOREBASE: DAUPHIN ISLAND, ALABAMA

CAT:09/21/96